

WILDEN[®]
Part of Pump Solutions Group
A **DOVER** COMPANY

EOM
Engineering
Operation &
Maintenance

P200/PX200
Advanced™ Series
Metal Pump

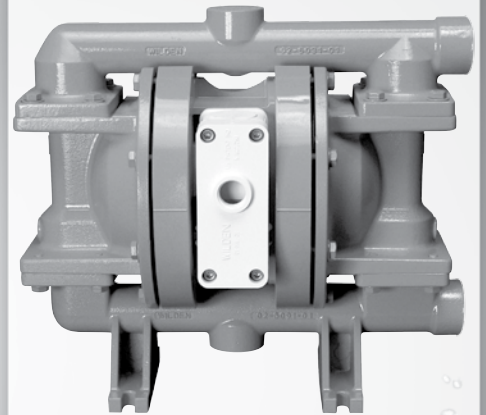

Where Innovation Flows

www.wildenpump.com



WIL-11080-E



PRO-FLO[®]
PROGRESSIVE PUMP TECHNOLOGY

PRO-FLO[™]
PROGRESSIVE PUMP TECHNOLOGY



WIL-11080-E-15
REPLACES WIL-11080-E-14

TABLE OF CONTENTS

SECTION 1 CAUTIONS—READ FIRST! 1

SECTION 2 WILDEN PUMP DESIGNATION SYSTEM 2

SECTION 3 HOW IT WORKS—PUMP & AIR DISTRIBUTION SYSTEM 3

SECTION 4 DIMENSIONAL DRAWINGS 4

SECTION 5 PERFORMANCE

 A. P200 Performance Curves

 Rubber-Fitted 8

 TPE-Fitted 8

 Reduced-Stroke PTFE-Fitted 9

 Full-Stroke PTFE-Fitted 9

 Suction-Lift Curves 10

 B. PX200 Performance

 Operating Principle 12

 How to Use this EMS Curve 13

 Performance Curves

 Rubber-Fitted 16

 TPE-Fitted 17

 Reduced-Stroke PTFE-Fitted 18

 Full-Stroke PTFE-Fitted 19

 Suction-Lift Curves 20

SECTION 6 SUGGESTED INSTALLATION, OPERATION & TROUBLESHOOTING 22

SECTION 7 ASSEMBLY / DISASSEMBLY 25

 Grounding Strap for CSA Pumps 27

 Air Valve Disassembly 28

 Reassembly Hints & Tips 31

SECTION 8 EXPLODED VIEW & PARTS LISTING

 P200 Full-Stroke 32

 P200 Reduced-Stroke 34

 PX200 Full-Stroke 36

 PX200 Reduced-Stroke 38

SECTION 9 ELASTOMER OPTIONS 40

CAUTIONS—READ FIRST!

 **CAUTION:** Do not apply compressed air to the exhaust port — pump will not function.

 **CAUTION:** Do not, under any circumstance loosen the set screw located at the adjuster dial of the Pro-Flo X™ pump. If the set screw is loose when the pump is pressurized, it could eject and cause injury to anyone in the area.

 **CAUTION:** Do not over-lubricate air supply — excess lubrication will reduce pump performance. Pump is pre-lubed.

 **Temperature Limits:**

Polypropylene	0°C to 79°C	32°F to 175°F
PVDF	-12°C to 107°C	10°F to 225°F
PFA	7°C to 107°C	20°F to 225°F
Neoprene	-18°C to 93°C	0°F to 200°F
Buna-N	-12°C to 82°C	10°F to 180°F
EPDM	-51°C to 138°C	-60°F to 280°F
Viton® FKM	-40°C to 177°C	-40°F to 350°F
Wil-Flex™	-40°C to 107°C	-40°F to 225°F
Saniflex™	-29°C to 104°C	-20°F to 220°F
Polyurethane	-12°C to 66°C	10°F to 150°F
Polytetrafluoroethylene (PTFE) ¹	4°C to 104°C	40°F to 220°F
Nylon	-18°C to 93°C	0°F to 200°F
Acetal	-29°C to 82°C	-20°F to 180°F
SIPD PTFE with Neoprene-backed	4°C to 104°C	40°F to 220°F
SIPD PTFE with EPDM-backed	-10°C to 137°C	14°F to 280°F
Polyethylene	0°C to 70°C	32°F to 158°F
Geolast®	-40°C to 82°C	-40°F to 180°F

¹4°C to 149°C (40°F to 300°F) - 13 mm (1/2") and 25 mm (1") models only.

NOTE: UL listed configured pumps have the following temperature limits:

UL 79 Buna-	-12°C (10°F) to 52°C (125°F)
UL 79 PTFE-	4°C (40°F) to 52°C (125°F)

 **CAUTION:** Canadian Standards Association (CSA) configured pumps should not be used in temperatures lower than 0.0°C to 52°C (32°F to 125°F).

 **CAUTION:** When choosing pump materials, be sure to check the temperature limits for all wetted components. Example: Viton® has a maximum limit of 177°C (350°F) but polypropylene has a maximum limit of only 79°C (175°F).

 **CAUTION:** Maximum temperature limits are based upon mechanical stress only. Certain chemicals will significantly reduce maximum safe operating temperatures. Consult Chemical Resistance Guide (E4) for chemical compatibility and temperature limits.

 **WARNING:** Prevent static sparking. If static sparking occurs, fire or explosion could result. Pump, valves and containers must be grounded to a proper grounding point when handling flammable fluids and whenever discharge of static electricity is a hazard.

 **CAUTION:** Canadian Standards Association (CSA) configured pumps must be electrically grounded using the grounding conductor provided. Improper grounding can cause improper and dangerous operation.

 **CAUTION:** For U.L. listed pumps, do not exceed 3.4 bar (50 psig) air supply pressure.

 **CAUTION:** Do not exceed 8.6 bar (125 psig) air supply pressure.

 **CAUTION:** Canadian Standards Association (CSA) configured pumps should not exceed 6.9 bar (100 psig) natural gas supply pressure.

 **CAUTION:** The process fluid and cleaning fluids must be chemically compatible with all wetted pump components. Consult Chemical Resistance Guide (E4).

 **CAUTION:** Do not exceed 82°C (180°F) air inlet temperature for Pro-Flo X™ models.

 **CAUTION:** Pumps should be thoroughly flushed before installing into process lines. FDA and USDA approved pumps should be cleaned and/or sanitized before being used.

 **CAUTION:** Always wear safety glasses when operating pump. If diaphragm rupture occurs, material being pumped may be forced out air exhaust.

 **CAUTION:** Before any maintenance or repair is attempted, the compressed air line to the pump should be disconnected and all air pressure allowed to bleed from pump. Disconnect all intake, discharge and air lines. Drain the pump by turning it upside down and allowing any fluid to flow into a suitable container.

 **CAUTION:** Blow out air line for 10 to 20 seconds before attaching to pump to make sure all pipeline debris is clear. Use an in-line air filter. A 5µ (micron) air filter is recommended.

 **NOTE:** When installing PTFE diaphragms, it is important to tighten outer pistons simultaneously (turning in opposite directions) to ensure tight fit. (See torque specifications in Section 7.)

 **NOTE:** Cast Iron PTFE-fitted pumps come standard from the factory with expanded PTFE gaskets installed in the diaphragm bead of the liquid chamber. PTFE gaskets cannot be re-used. Consult PS-TG for installation instructions during reassembly. *This excludes Pro-Flo® P200 Advanced™ metal pumps.*

 **NOTE:** Before starting disassembly, mark a line from each liquid chamber to its corresponding air chamber. This line will assist in proper alignment during reassembly.

 **CAUTION:** Pro-Flo X™ pumps can be used for submersible applications, when using the Pro-Flo X™ submersible option. Turbo-Flo™ pumps can also be used for submersible applications when using the Turbo-Flo™ submersible option.

 **CAUTION:** Tighten all hardware prior to installation.

 **CAUTION:** The gas outlet of CSA configured pumps must be vented to a safe location in accordance with local codes or, in the absence of local codes, an industry or nationally recognized code having jurisdiction over the specified installation.

 **CAUTION:** For U.L. listed pumps, all pipe connections are to be made using U.L. classified gasoline-resistant pipe compound.

 **CAUTION:** For U.L. listed pumps all installations must conform to NFPA 30, NFPA 30A and all other applicable codes.

 **CAUTION:** For U.L. listed pumps, air exhaust port is to be connected to pipe or tubing to be routed outdoors or other location determined to be equivalent.

 **CAUTION:** For U.L. listed pumps, pump is to be grounded using the jam-nut located at the top of the long vertical carriage bolt. The ground connection is marked with a tag having the grounding symbol.



Grounding Symbol

WILDEN PUMP DESIGNATION SYSTEM

**P200 & PX200
ADVANCED™
METAL**

**25 mm (1") Pump
Maximum Flow Rate:
212 lpm (56 gpm)**

LEGEND

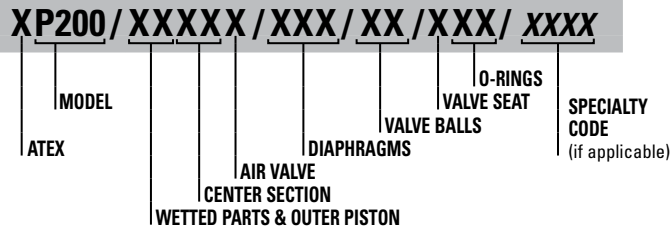

MATERIAL CODES

MODEL

- P200 = PRO-FLO®
- XP200 = ATEX PRO-FLO X™
- PX200 = PRO-FLO X™
- XPX200 = ATEX PRO-FLO X™

WETTED PARTS & OUTER PISTON

- AA = ALUMINUM / ALUMINUM
- SS = STAINLESS STEEL / STAINLESS STEEL
- WW = DUCTILE IRON / DUCTILE IRON

CENTER SECTION

- AA = ALUMINUM
- PP = POLYPROPYLENE
- LL = ACETAL
- JJ = CONDUCTIVE POLYPROPYLENE

AIR VALVE

- A = ALUMINUM
- P = POLYPROPYLENE
- L = ACETAL
- J = CONDUCTIVE POLYPROPYLENE

DIAPHRAGMS

- BNS = BUNA-N (Red Dot)
- EPS = EPDM (Blue Dot)
- ESD = BUNA-N
- FSS = SANIFLEX™ [Hytrel® (Cream)]
- NES = NEOPRENE (Green Dot)
- PUS = POLYURETHANE (Clear)
- TEU = PTFE w/EPDM BACK-UP (White)
- TNU = PTFE w/NEOPRENE BACK-UP (White)
- TSS = FULL-STROKE PTFE w/SANIFLEX™ BACK-UP
- TSU = PTFE w/SANIFLEX™ BACK-UP (White)
- TWS = FULL-STROKE PTFE
- TXU = PTFE w/CONDUCTIVE BUNA-N BACK-UP w/WIL-FLEX™ BACK-UP
- VTS = VITON® (White Dot)
- WFS = WIL-FLEX™ [Santoprene® (Orange Dot)]
- XBS = CONDUCTIVE BUNA-N (Two Red Dots)

VALVE BALL

- BN = BUNA-N (Red Dot)
- FS = SANIFLEX™ [Hytrel® (Cream)]
- EP = EPDM (Blue Dot)
- NE = NEOPRENE (Green Dot)
- PU = POLYURETHANE (Brown)
- TF = PTFE (White)
- VT = VITON® (White Dot)
- WF = WIL-FLEX™ [Santoprene® (Orange Dot)]

VALVE SEAT

- A = ALUMINUM
- M = MILD STEEL
- S = STAINLESS STEEL

VALVE SEAT & MANIFOLD O-RING

- BN = BUNA-N
- FS = SANIFLEX™ [Hytrel® (Cream)]
- EP = EPDM
- NE = NEOPRENE
- PU = POLYURETHANE (Brown)
- TF = PTFE (White)
- VT = VITON®
- WF = WIL-FLEX™ [Santoprene® (Orange Dot)]

SPECIALTY CODES

0014 25 mm (1") BSPT side-ported inlet and discharge	0677 25 mm (1") NPT center-ported inlet and discharge manifold	0698 19 mm (3/4") BSPT center-ported discharge manifold (Pro-Flo "Drop-in")
0320 Single-point exhaust	0678 25 mm (1") BSPT center-ported inlet and discharge manifold	0730 25 mm (1") NPT side-ported inlet and discharge
0391 25 mm (1") NPT center-ported inlet and discharge manifold, CSA	0687 25 mm (1") NPT center-ported inlet and discharge manifold, Submersible Center Section	0735 19 mm (3/4") NPT center-ported discharge manifold (Turbo-Flo "Drop-in"), Submersible Center Section
0392 25 mm (1") NPT side-ported inlet and discharge manifold, CSA	0688 25 mm (1") BSPT center-ported inlet and discharge manifold, Submersible Center Section	0736 19 mm (3/4") BSPT center-ported discharge manifold (Turbo-Flo "Drop-in"), Submersible Center Section
0492 U.L. Approved, Side-ported (1" inlet and discharge manifolds)	0695 19 mm (3/4") NPT center-ported discharge manifold (Turbo-Flo "Drop-in")	0737 19 mm (3/4") NPT center-ported discharge manifold (Pro-Flo "Drop-in"), Submersible Center Section
0493 U.L. Approved, Center Ported NPT, Turbo "drop-in" (1" Inlet facing air inlet, 3/4" discharge facing exhaust)	0696 19 mm (3/4") BSPT center-ported discharge manifold (Turbo-Flo "Drop-in")	0738 19 mm (3/4") BSPT center-ported discharge manifold (Pro-Flo "Drop-in"), Submersible Center Section
0494 U.L. Approved, Center Ported NPT, Pro-Flo "drop-in" (1" inlet facing exhaust, 3/4" discharge facing air inlet)	0697 19 mm (3/4") NPT center-ported discharge manifold (Pro-Flo "Drop-in")	

NOTE: The Wilden UL 79 Listed products covered by this manual are PX200 models followed by AA or SS, followed by AA, followed by A, followed by BNS or TNU, followed by BN or TF, followed by A or S, followed by BN or TF, followed by 0492, 0493 or 0494. Wilden UL Listed pumps have been evaluated for use at a 25° C (77° F) ambient temperature with a maximum inlet pressure of 3.4 bar (50 psi).

NOTE: MOST ELASTOMERIC MATERIALS USE COLORED DOT FOR IDENTIFICATION

Viton® is a registered trademark of Dupont Dow Elastomers.

HOW IT WORKS — PUMP

The Wilden diaphragm pump is an air-operated, positive displacement, self-priming pump. These drawings show flow pattern through the pump upon its initial stroke. It is assumed the pump has no fluid in it prior to its initial stroke.

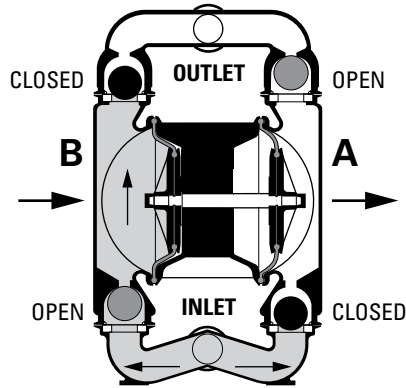

FIGURE 1 The air valve directs pressurized air to the back side of diaphragm A. The compressed air is applied directly to the liquid column separated by elastomeric diaphragms. The diaphragm acts as a separation membrane between the compressed air and liquid, balancing the load and removing mechanical stress from the diaphragm. The compressed air moves the diaphragm away from the center of the pump. The opposite diaphragm is pulled in by the shaft connected to the pressurized diaphragm. Diaphragm B is on its suction stroke; air behind the diaphragm has been forced out to atmosphere through the exhaust port of the pump. The movement of diaphragm B toward the center of the pump creates a vacuum within chamber B. Atmospheric pressure forces fluid into the inlet manifold forcing the inlet valve ball off its seat. Liquid is free to move past the inlet valve ball and fill the liquid chamber (see shaded area).

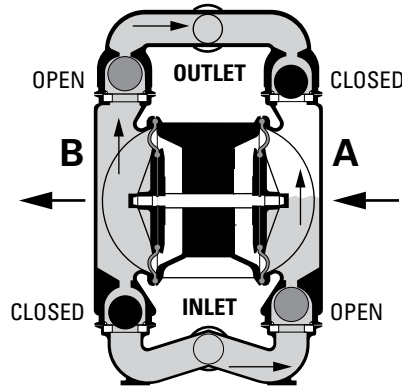

FIGURE 2 When the pressurized diaphragm, diaphragm A, reaches the limit of its discharge stroke, the air valve redirects pressurized air to the back side of diaphragm B. The pressurized air forces diaphragm B away from the center while pulling diaphragm A to the center. Diaphragm B is now on its discharge stroke. Diaphragm B forces the inlet valve ball onto its seat due to the hydraulic forces developed in the liquid chamber and manifold of the pump. These same hydraulic forces lift the discharge valve ball off its seat, forcing fluid to flow through the pump discharge. The movement of diaphragm A toward the center of the pump creates a vacuum within liquid chamber A. Atmospheric pressure forces fluid into the inlet manifold of the pump. The inlet valve ball is forced off its seat allowing the fluid being pumped to fill the liquid chamber.

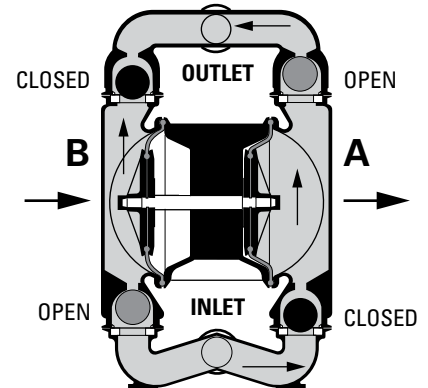
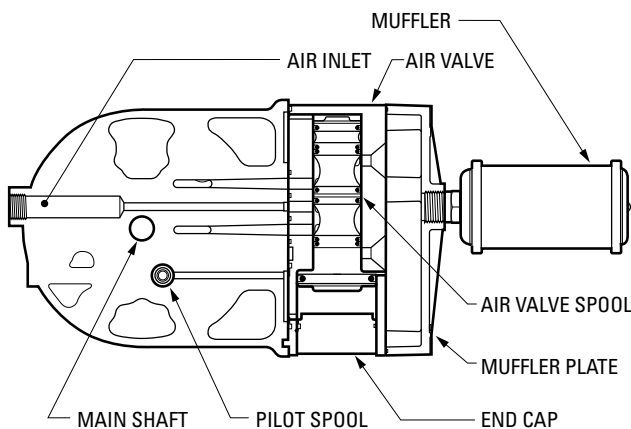

FIGURE 3 At completion of the stroke, the air valve again redirects air to the back side of diaphragm A, which starts diaphragm B on its suction stroke. As the pump reaches its original starting point, each diaphragm has gone through one suction and one discharge stroke. This constitutes one complete pumping cycle. The pump may take several cycles to completely prime depending on the conditions of the application.

HOW IT WORKS — AIR DISTRIBUTION SYSTEM



The Pro-Flo® patented air distribution system incorporates two moving parts: the air valve spool and the pilot spool. The heart of the system is the air valve spool and air valve. This valve design incorporates an unbalanced spool. The smaller end of the spool is pressurized continuously, while the large end is alternately pressurized then exhausted to move the spool. The spool directs pressurized air to one air chamber while exhausting the other. The air causes the main shaft/diaphragm assembly to shift to one side — discharging liquid on that side and pulling liquid in on the other side. When the shaft reaches the end of its stroke, the inner piston actuates the pilot spool, which pressurizes and exhausts the large end of the air valve spool. The repositioning of the air valve spool routes the air to the other air chamber.

DIMENSIONAL DRAWINGS

P200 Advanced™ Metal—Threaded

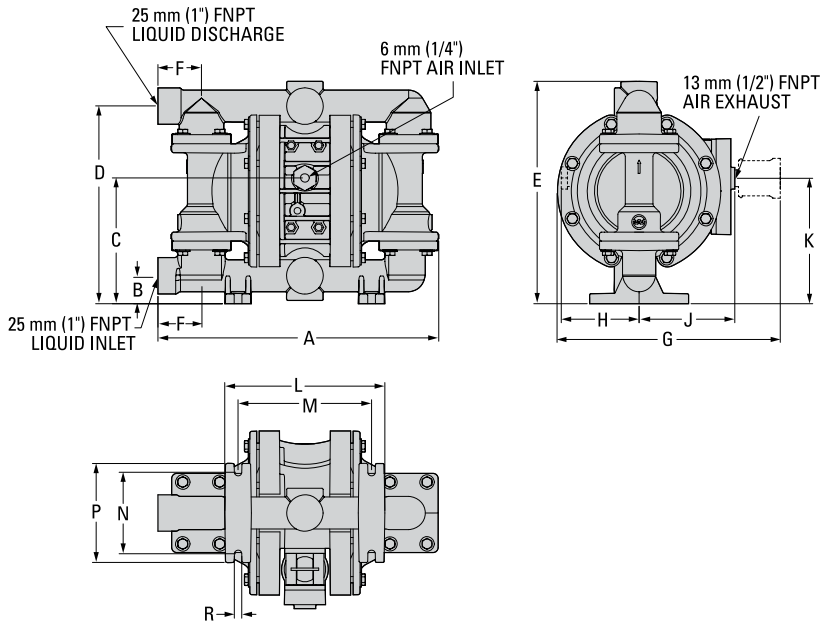

DIMENSIONS

ITEM	METRIC (mm)	STANDARD (inch)
A	361	14.2
B	36	1.4
C	163	6.4
D	254	10.0
E	287	11.3
F	56	2.2
G	287	11.3
H	99	3.9
J	122	4.8
K	160	6.3
L	206	8.1
M	173	6.8
N	104	4.1
P	127	5.0
R	10	0.4

REV. C

P200 Advanced™ Metal—Center-Ported

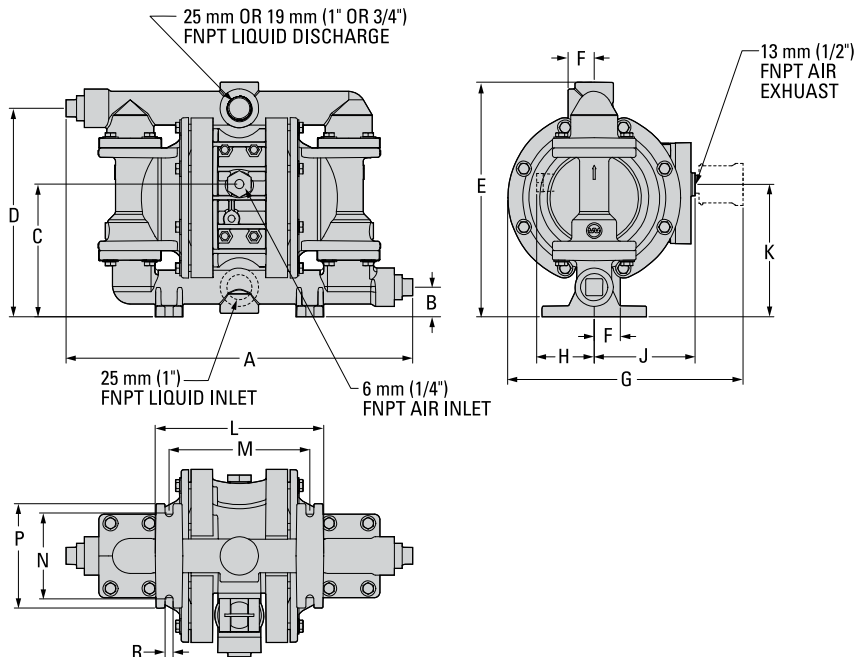

DIMENSIONS

ITEM	METRIC (mm)	STANDARD (inch)
A	422	16.6
B	36	1.4
C	160	6.3
D	254	10.0
E	287	11.3
F	33	1.3
G	287	11.3
H	71	2.8
J	122	4.8
K	163	6.4
L	206	8.1
M	173	6.8
N	104	4.1
P	127	5.0
R	10	0.4

REV. C

**P200 Advanced™
Stainless Steel – Flanged**

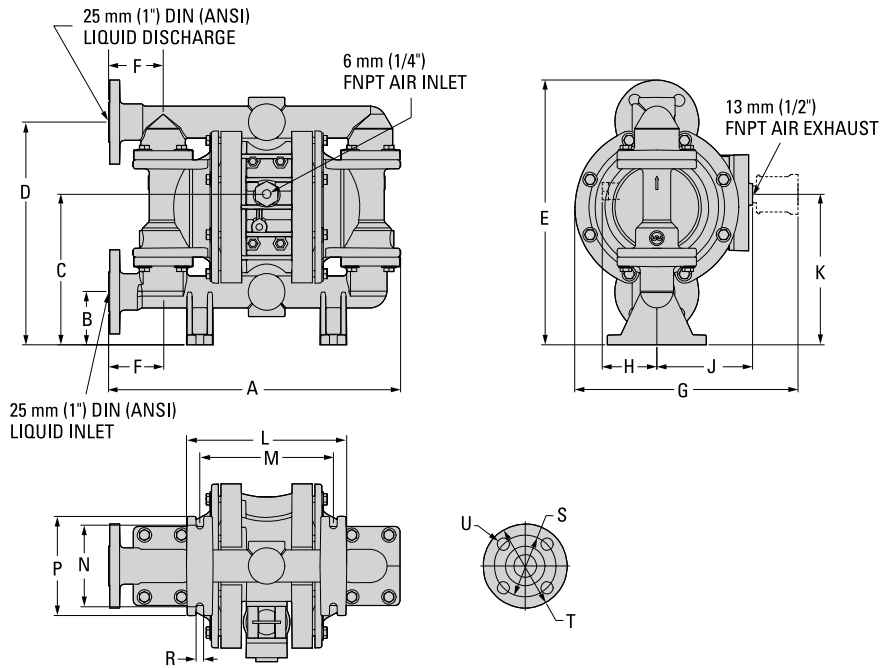

DIMENSIONS

ITEM	METRIC (mm)	STANDARD (inch)
A	373	14.7
B	69	2.7
C	195	7.6
D	287	11.3
E	340	13.4
F	71	2.8
G	287	11.3
H	71	2.8
J	122	4.8
K	193	7.6
L	206	8.1
M	173	6.8
N	104	4.1
P	127	5.0
R	10	0.4
DIN FLANGE		
S	85 DIA.	3.3 DIA.
T	115 DIA.	4.5 DIA.
U	14 DIA.	0.6 DIA.
ANSI FLANGE		
S	79 DIA.	3.1 DIA.
T	109 DIA.	4.3 DIA.
U	14 DIA.	0.6 DIA.

REV. B

PX200 Advanced™ Metal—Threaded

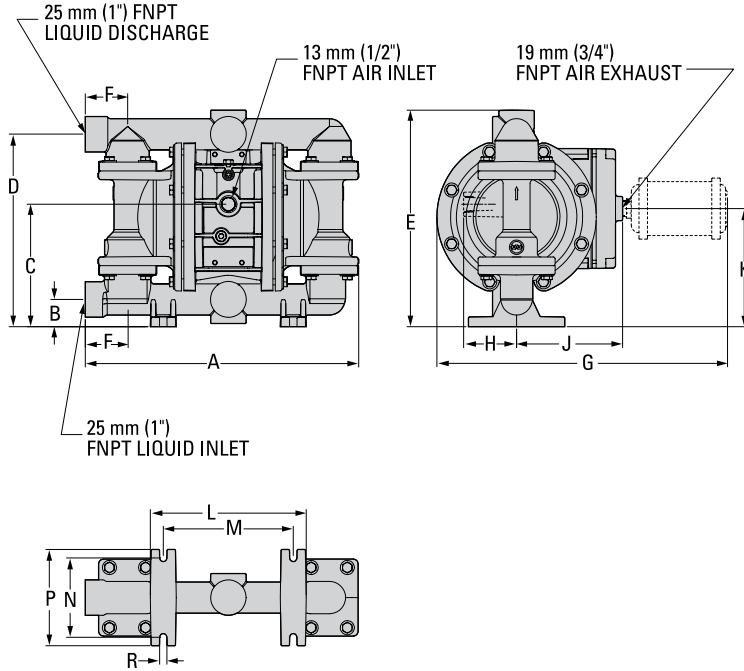

DIMENSIONS

ITEM	METRIC (mm)	STANDARD (inch)
A	361	14.2
B	36	1.4
C	163	6.4
D	254	10.0
E	287	11.3
F	56	2.2
G	384	15.1
H	71	2.8
J	140	5.5
K	155	6.1
L	206	8.1
M	173	6.8
N	104	4.1
P	127	5.0
R	10	0.4

REV. B

PX200 Advanced™ Metal—Center-Ported

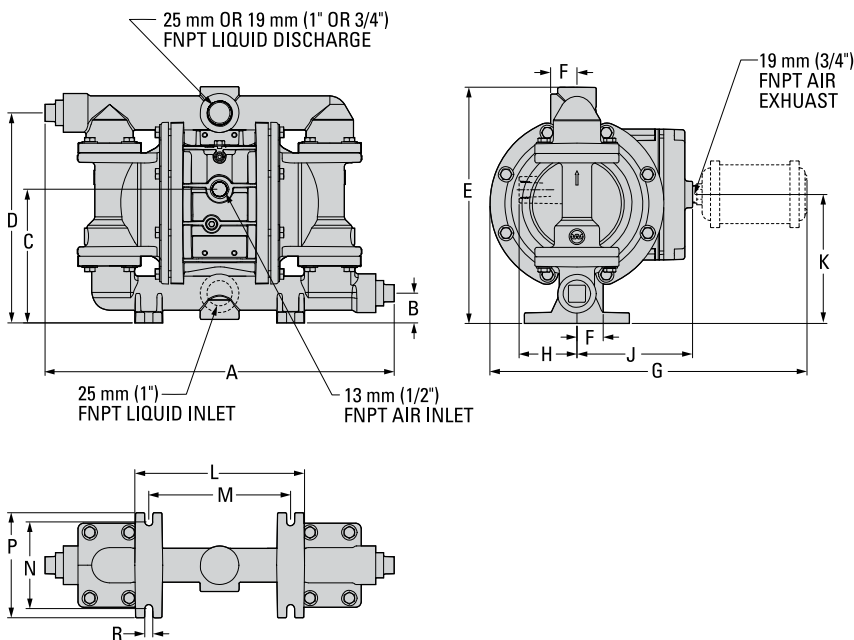

DIMENSIONS

ITEM	METRIC (mm)	STANDARD (inch)
A	422	16.6
B	36	1.4
C	163	6.4
D	254	10.0
E	287	11.3
F	33	1.3
G	384	15.1
H	71	2.8
J	140	5.5
K	155	6.1
L	206	8.1
M	173	6.8
N	104	4.1
P	127	5.0
R	10	0.4

**PX200 Advanced™
Stainless Steel – Flanged**

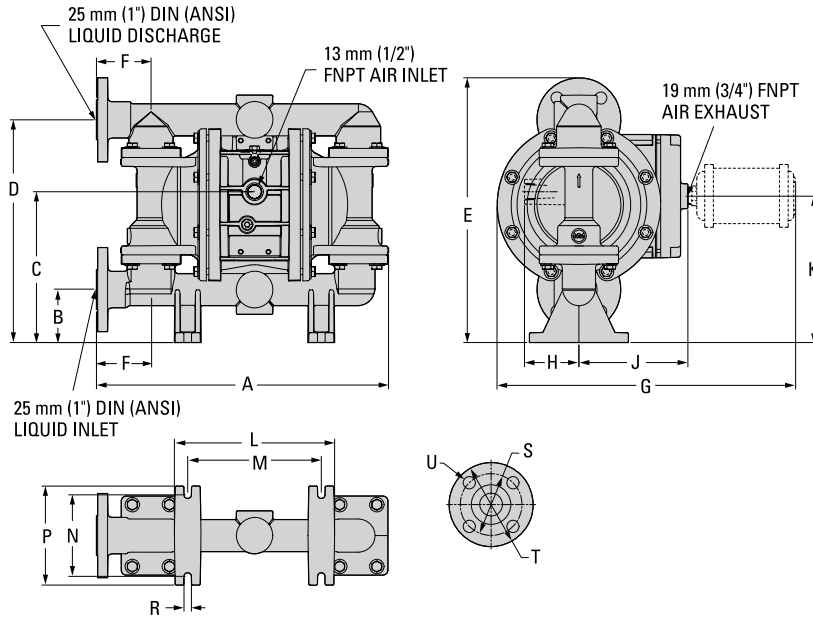

DIMENSIONS

ITEM	METRIC (mm)	STANDARD (inch)
A	373	14.7
B	69	2.7
C	195	7.6
D	287	11.3
E	340	13.4
F	71	2.8
G	384	15.1
H	71	2.8
J	140	5.5
K	188	7.4
L	206	8.1
M	173	6.8
N	104	4.1
P	127	5.0
R	10	0.4
DIN FLANGE		
S	85 DIA.	3.3 DIA.
T	115 DIA.	4.5 DIA.
U	14 DIA.	0.6 DIA.
ANSI FLANGE		
S	79 DIA.	3.1 DIA.
T	109 DIA.	4.3 DIA.
U	14 DIA.	0.6 DIA.

PERFORMANCE

P200 ADVANCED™ METAL RUBBER-FITTED

Height 340 mm (13.4")
 Width 343 mm (14.7")
 Depth 229 mm (9.0")
 Ship Weight Aluminum 11 kg (24 lb)
 Ductile Iron 21 kg (47 lb)
 316 Stainless Steel 23 kg (51 lb)
 Air Inlet 6 mm (1/4")
 Inlet 25 mm (1")
 Outlet 25 mm (1")
 Suction Lift 5.4 m Dry (17.6')
 9.3 m Wet (30.6')
 Disp. Per Stroke 0.30 L (0.08 gal)¹
 Max. Flow Rate 212 lpm (56 gpm)
 Max. Size Solids 6.4 mm (1/4")

¹Displacement per stroke was calculated at 4.8 bar (70 psig) air inlet pressure against a 2.1 bar (30 psig) head pressure.

Example: To pump 56.8 lpm (15 gpm) against a discharge pressure head of 3.3 bar (48 psig) requires 4.1 bar (60 psig) and 34 Nm³/h (20 scfm) air consumption. (See dot on chart.)

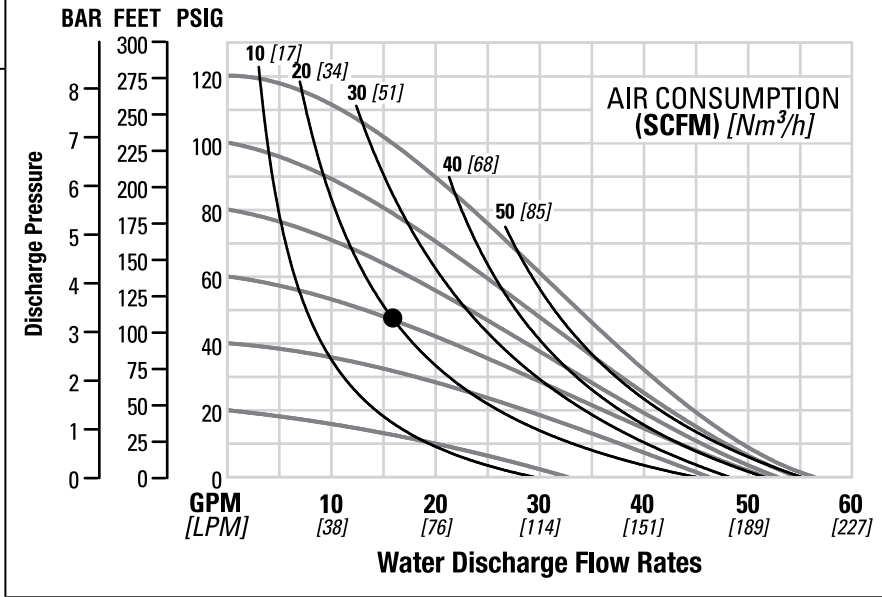

Flow rates indicated on chart were determined by pumping water.

For optimum life and performance, pumps should be specified so that daily operation -parameters will fall in the center of the pump's performance curve.

Caution: Do not exceed 8.6 bar (125 psig) air supply pressure. Canadian Standards Association (CSA) configured pumps should not exceed 6.9 bar (100 psig) natural gas supply pressure. Please read all cautions and suggested installation sections before operating any Wilden product.

P200 ADVANCED™ METAL TPE-FITTED

Height 340 mm (13.4")
 Width 373 mm (14.7")
 Depth 229 mm (9.0")
 Ship Weight Aluminum 11 kg (24 lb)
 Ductile Iron 21 kg (47 lb)
 316 Stainless Steel 23 kg (51 lb)
 Air Inlet 6 mm (1/4")
 Inlet 25 mm (1")
 Outlet 25 mm (1")
 Suction Lift 4.1 m Dry (13.6')
 9.3 m Wet (30.6')
 Disp. Per Stroke 0.34 L (0.09 gal)¹
 Max. Flow Rate 212 lpm (56 gpm)
 Max. Size Solids 6.4 mm (1/4")

¹Displacement per stroke was calculated at 4.8 bar (70 psig) air inlet pressure against a 2.1 bar (30 psig) head pressure.

Example: To pump 60.6 lpm (16 gpm) against a discharge pressure head of 3.2 bar (47 psig) requires 4.1 bar (60 psig) and 34 Nm³/h (20 scfm) air consumption. (See dot on chart.)

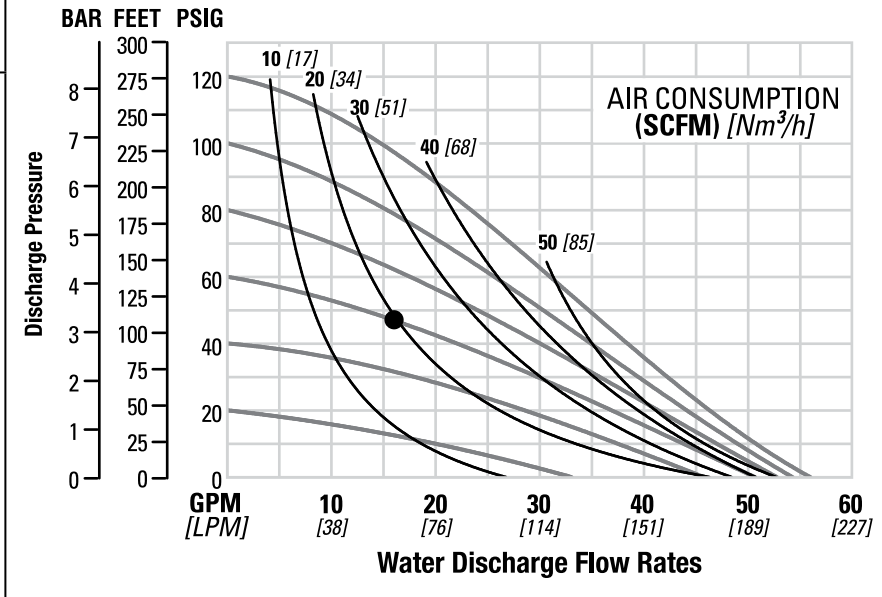

Flow rates indicated on chart were determined by pumping water.

For optimum life and performance, pumps should be specified so that daily operation -parameters will fall in the center of the pump's performance curve.

Caution: Do not exceed 8.6 bar (125 psig) air supply pressure. Canadian Standards Association (CSA) configured pumps should not exceed 6.9 bar (100 psig) natural gas supply pressure. Please read all cautions and suggested installation sections before operating any Wilden product.

**P200 ADVANCED™ METAL
REDUCED-STROKE PTFE-FITTED**

Height 340 mm (13.4")
 Width 373 mm (14.7")
 Depth 229 mm (9.0")
 Ship Weight Aluminum 11 kg (24 lb)
 Ductile Iron 21 kg (47 lb)
 316 Stainless Steel 23 kg (51 lb)
 Air Inlet 6 mm (1/4")
 Inlet 25 mm (1")
 Outlet 25 mm (1")
 Suction Lift 3.5 m Dry (11.4')
 9.3 m Wet (30.6')
 Disp. Per Stroke 0.23 L (0.06 gal)¹
 Max. Flow Rate 168 lpm (44 gpm)
 Max. Size Solids 6.4 mm (1/4")

¹Displacement per stroke was calculated at 4.8 bar (70 psig) air inlet pressure against a 2.1 bar (30 psig) head pressure.

Example: To pump 45.4 lpm (12 gpm) against a discharge pressure head of 3.2 bar (47 psig) requires 4.1 bar (60 psig) and 34 Nm³/h (20 scfm) air consumption. (See dot on chart.)

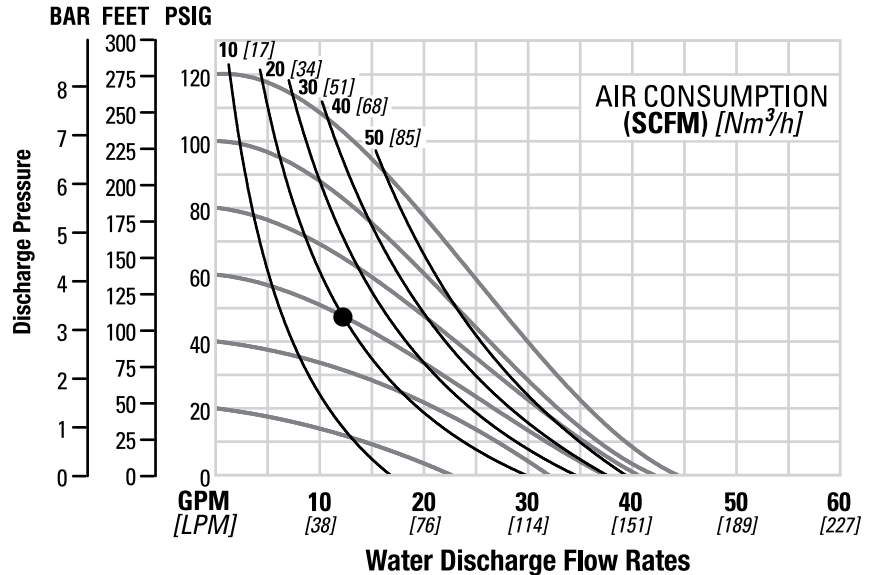

Flow rates indicated on chart were determined by pumping water.

For optimum life and performance, pumps should be specified so that daily operation -parameters will fall in the center of the pump's performance curve.

Caution: Do not exceed 8.6 bar (125 psig) air supply pressure. Canadian Standards Association (CSA) configured pumps should not exceed 6.9 bar (100 psig) natural gas supply pressure. Please read all cautions and suggested installation sections before operating any Wilden product.

**P200 ADVANCED™ METAL
FULL-STROKE PTFE-FITTED**

Height 340 mm (13.4")
 Width 378 mm (14.7")
 Depth 244 mm (9.6")
 Ship Weight Stainless Steel 23 kg (51 lb)
 Aluminum 11 kg (24 lb)
 Cast Iron 21 kg (47 lb)
 Air Inlet 6 mm (1/4")
 Inlet 25 mm (1")
 Outlet 25 mm (1")
 Suction Lift 5.5m Dry (18.2')
 9.0 m Wet (29.5')
 Disp. Per Stroke 0.3 L (0.8 gal)¹
 Max. Flow Rate 185 lpm (49 gpm)
 Max. Size Solids 6.4 mm (1/4")

¹Displacement per stroke was calculated at 4.8 bar (70 psig) air inlet pressure against a 2.1 bar (30 psig) head pressure.

Example: To pump 75.7 lpm (20 gpm) against a discharge head of 3.1 bar (45 psig) requires 4.1 bar (60 psig) and 36.9 Nm³/h (23 scfm) air consumption.

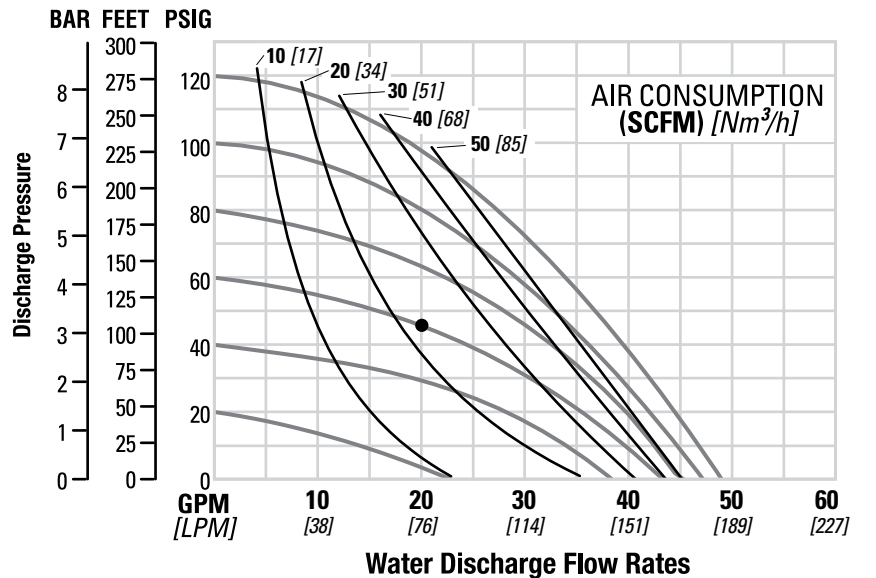

Flow rates indicated on chart were determined by pumping water.

For optimum life and performance, pumps should be specified so that daily operation -parameters will fall in the center of the pump's performance curve.

Caution: Do not exceed 8.6 bar (125 psig) air supply pressure. Canadian Standards Association (CSA) configured pumps should not exceed 6.9 bar (100 psig) natural gas supply pressure. Please read all cautions and suggested installation sections before operating any Wilden product.

SUCTION-LIFT CURVE

**P200 ADVANCED™
METAL SUCTION-LIFT
CAPABILITY**

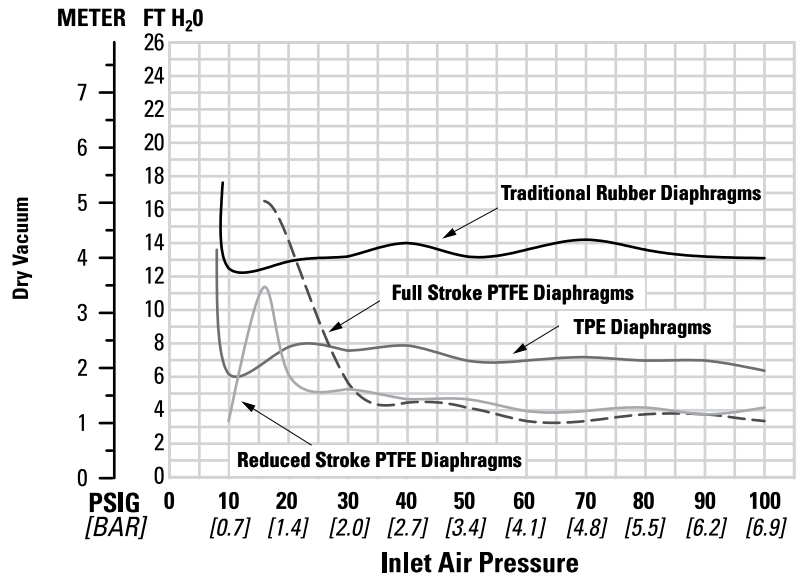

PX200

M E T A L

WILDEN
A DOVER COMPANY

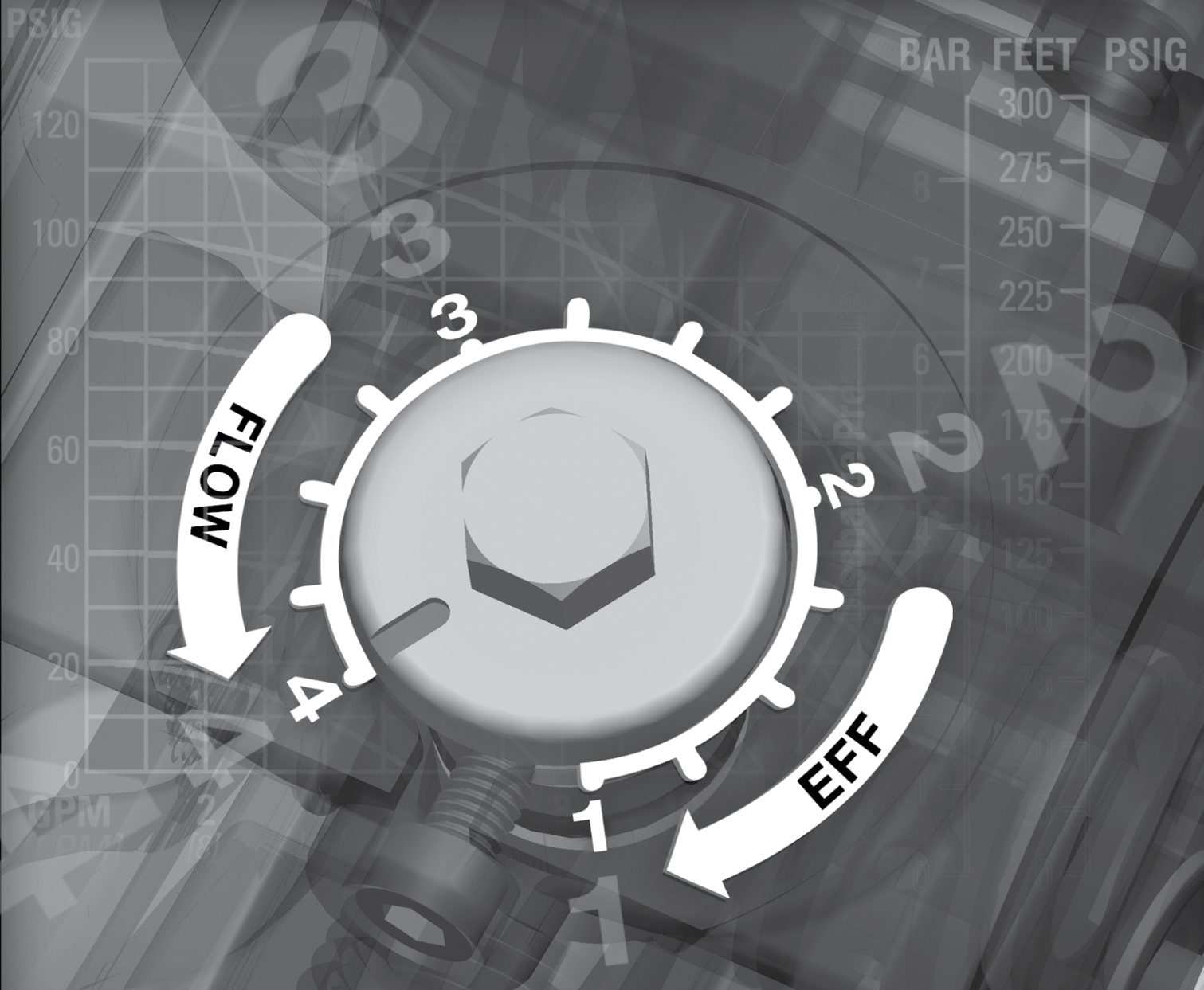

PROFLO™
PROGRESSIVE PUMP TECHNOLOGY

PX200 PERFORMANCE



Pro-Flo X™ Operating Principle

The Pro-Flo X™ air distribution system with the revolutionary Efficiency Management System (EMS) offers flexibility never before seen in the world of AODD pumps. The patent-pending EMS is simple and easy to use. With the turn of an integrated

control dial, the operator can select the optimal balance of flow and efficiency that best meets the application needs. Pro-Flo X™ provides higher

performance, lower operational costs and flexibility that exceeds previous industry standards.



<p>Turning the dial changes the relationship between air inlet and exhaust porting.</p>	<p>Each dial setting represents an entirely different flow curve.</p>	<p>Pro-Flo X™ pumps are shipped from the factory on setting 4, which is the highest flow rate setting possible.</p>	<p>Moving the dial from setting 4 causes a decrease in flow and an even greater decrease in air consumption.</p>	<p>When the air consumption decreases more than the flow rate, efficiency is improved and operating costs are reduced.</p>

Example 1

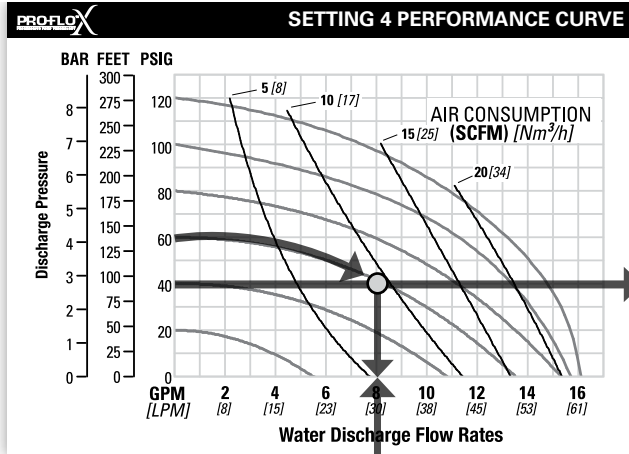

Figure 1

Example data point = **8.2** GPM

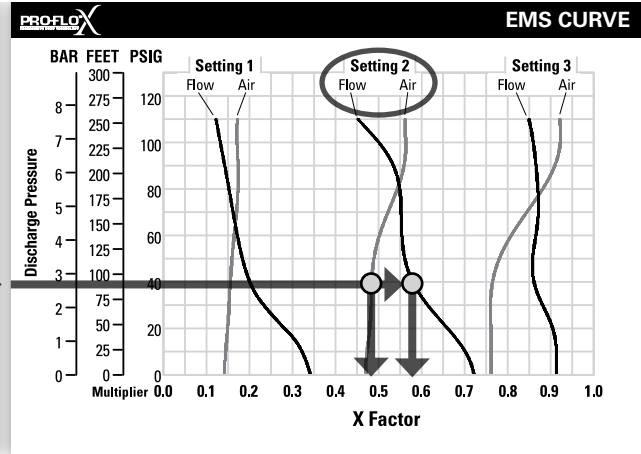

Figure 2

Example data point = **0.58** flow multiplier
0.48 air multiplier

This is an example showing how to determine flow rate and air consumption for your Pro-Flo X™ pump using the Efficiency Management System (EMS) curve and the performance curve. For this example we will be using 4.1 bar (60 psig) inlet air pressure and 2.8 bar (40 psig) discharge pressure and EMS setting 2.

Step 1: Identifying performance at setting 4. Locate the curve that represents the flow rate of the pump with 4.1 bar (60 psig) air inlet pressure. Mark the point where this curve crosses the horizontal line representing 2.8 bar (40 psig) discharge pressure (Figure 1). After locating your performance point on the flow curve, draw a vertical line downward until reaching the bottom scale on the chart. Identify the flow rate (in this case, 8.2 gpm). Observe location of performance point relative to air consumption curves and approximate air consumption value (in this case, 9.8 scfm).

Step 2: Determining flow and air X Factors. Locate your discharge pressure [2.8 bar (40 psig)] on the vertical axis of the EMS curve (Figure 2). Follow along the 2.8 bar (40 psig) horizontal line until intersecting both flow and air curves for your desired EMS setting (in this case, setting 2). Mark the points where the EMS curves intersect the horizontal discharge pressure line. After locating your EMS points on the

EMS curve, draw vertical lines downward until reaching the bottom scale on the chart. This identifies the flow X Factor (in this case, 0.58) and air X Factor (in this case, 0.48).

Step 3: Calculating performance for specific EMS setting. Multiply the flow rate (8.2 gpm) obtained in Step 1 by the flow X Factor multiplier (0.58) in Step 2 to determine the flow rate at EMS setting 2. Multiply the air consumption (9.8 scfm) obtained in Step 1 by the air X Factor multiplier (0.48) in Step 2 to determine the air consumption at EMS setting 2 (Figure 3).

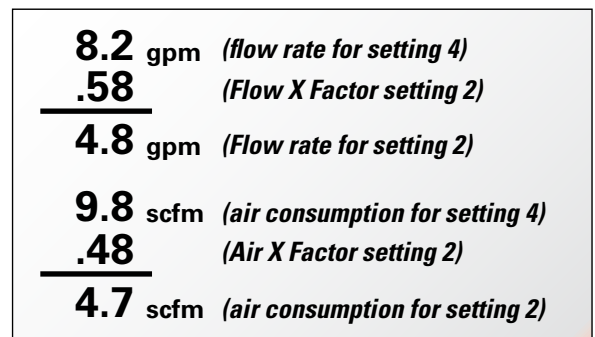

Figure 3

The flow rate and air consumption at Setting 2 are found to be 18.2 lpm (4.8 gpm) and 7.9 Nm³/h (4.7 scfm) respectively.

Example 2.1

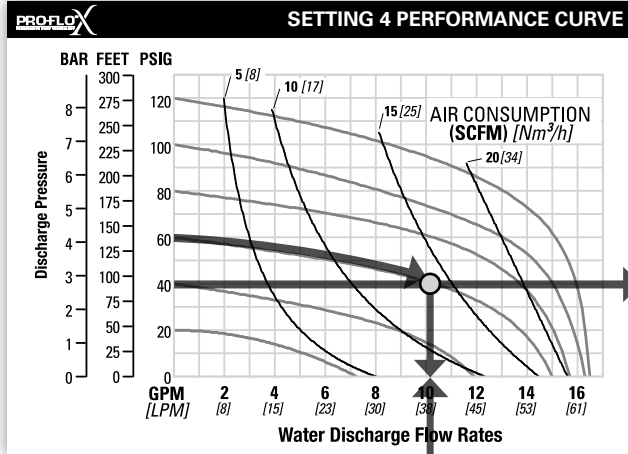

Figure 4

Example data point = **10.2** gpm

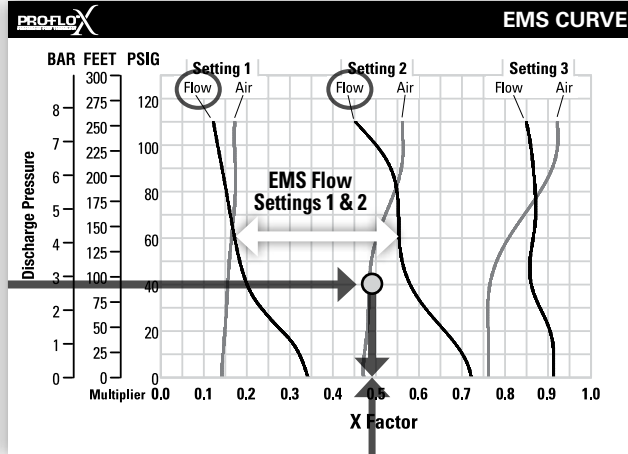

Figure 5

0.49 flow multiplier

This is an example showing how to determine the inlet air pressure and the EMS setting for your Pro-Flo X™ pump to optimize the pump for a specific application. For this example we will be using an application requirement of 18.9 lpm (5 gpm) flow rate against 2.8 bar (40 psig) discharge pressure. This example will illustrate how to calculate the air consumption that could be expected at this operational point.

DETERMINE EMS SETTING

Step 1: Establish inlet air pressure. Higher air pressures will typically allow the pump to run more efficiently, however, available plant air pressure can vary greatly. If an operating pressure of 6.9 bar (100 psig) is chosen when plant air frequently dips to 6.2 bar (90 psig) pump performance will vary. Choose an operating pressure that is within your compressed air system's capabilities. For this example we will choose 4.1 bar (60 psig).

Step 2: Determine performance point at setting 4. For this example an inlet air pressure of 4.1 bar (60 psig) inlet air pressure has been chosen. Locate the curve that represents the performance of the pump with 4.1 bar (60 psig) inlet air pressure. Mark the point where this curve crosses the horizontal line representing 2.8 bar (40 psig) discharge pressure. After locating this point on the flow curve, draw a vertical line downward until reaching the bottom scale on the chart and identify the flow rate.

In our example it is 38.6 lpm (10.2 gpm). This is the setting 4 flow rate. Observe the location of the performance point relative to air consumption curves and approximate air consumption value. In our example setting 4 air consumption is 24 Nm³/h (14 scfm). (See figure 4.)

Step 3: Determine flow X Factor. Divide the required flow rate 18.9 lpm (5 gpm) by the setting 4 flow rate 38.6 lpm (10.2 gpm) to determine the flow X Factor for the application.

$$5 \text{ gpm} / 10.2 \text{ gpm} = 0.49 \text{ (flow X Factor)}$$

Step 4: Determine EMS setting from the flow X Factor. Plot the point representing the flow X Factor (0.49) and the application discharge pressure 2.8 bar (40 psig) on the EMS curve. This is done by following the horizontal 2.8 bar (40 psig) discharge pressure line until it crosses the vertical 0.49 X Factor line. Typically, this point lies between two flow EMS setting curves (in this case, the point lies between the flow curves for EMS setting 1 and 2). Observe the location of the point relative to the two curves it lies between and approximate the EMS setting (Figure 5). For more precise results you can mathematically interpolate between the two curves to determine the optimal EMS setting.

For this example the EMS setting is 1.8.

Example 2.2

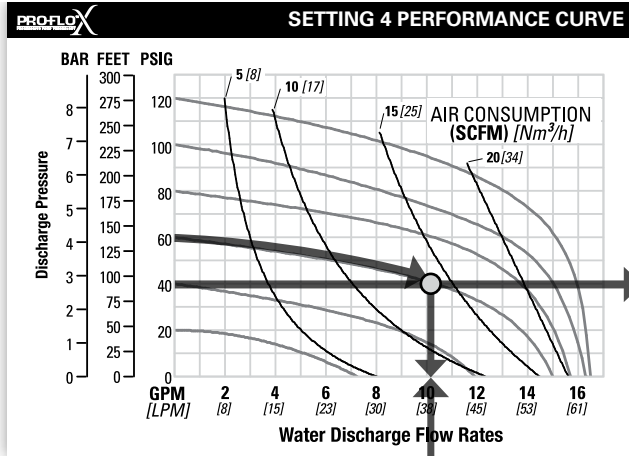

Figure 6

Example data point = **10.2** gpm

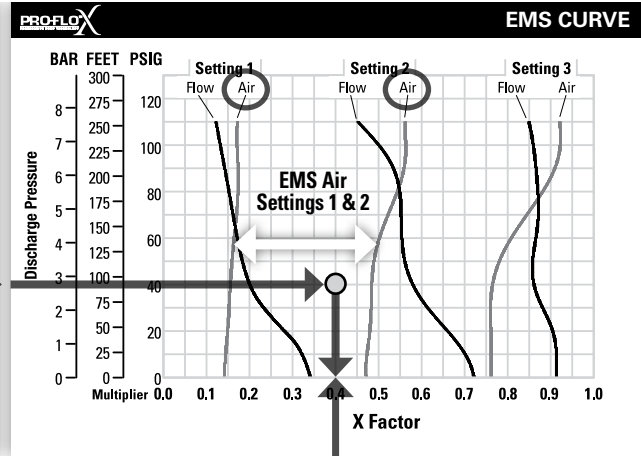

Figure 7

Example data point = **0.40** air multiplier

Determine air consumption at a specific EMS setting.

Step 1: Determine air X Factor. In order to determine the air X Factor, identify the two air EMS setting curves closest to the EMS setting established in example 2.1 (in this case, the point lies between the air curves for EMS setting 1 and 2). The point representing your EMS setting (1.8) must be approximated and plotted on the EMS curve along the horizontal line representing your discharge pressure (in this case, 40 psig). This air point is different than the flow point plotted in example 2.1. After estimating (or interpolating) this point on the curve, draw a vertical line downward until reaching the bottom scale on the chart and identify the air X Factor (Figure 7).

For this example the air X Factor is **0.40**.

Step 2: Determine air consumption. Multiply your setting 4 air consumption (14 scfm) value by the air X Factor obtained above (0.40) to determine your actual air consumption.

$$14 \text{ scfm} \times 0.40 = 5.6 \text{ SCFM}$$

In summary, for an application requiring 18.9 lpm (5 gpm) against 2.8 bar (40 psig) discharge pressure, the pump inlet air pressure should be set to 4.1 bar (60 psig) and the EMS dial should be set to 1.8. The pump would then consume 9.5 Nm³/h (5.6 scfm) of compressed air.

PX200 METAL RUBBER-FITTED



PERFORMANCE



SETTING 4 PERFORMANCE CURVE

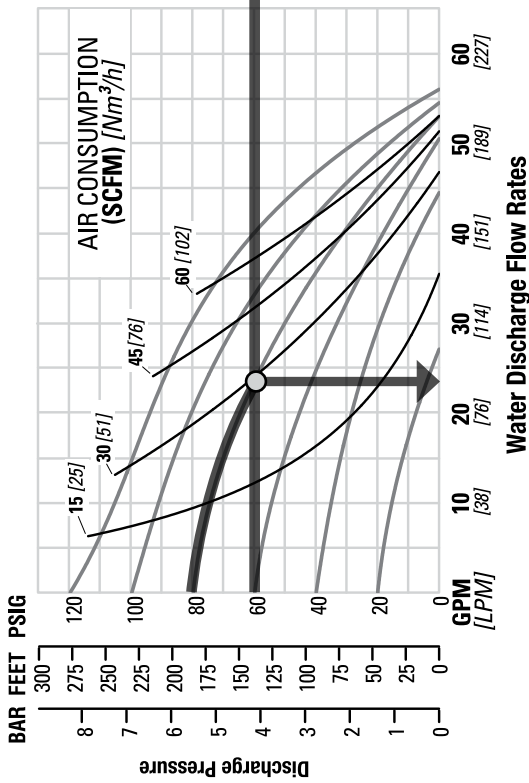

EMS CURVE

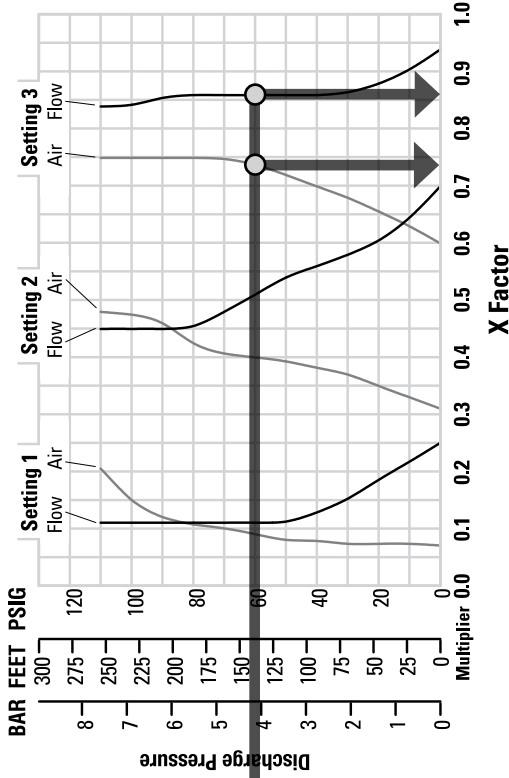

TECHNICAL DATA

Height	340 mm (13.4")
Width	378 mm (14.7")
Depth	244 mm (9.6")
Ship Weight	Aluminum 15 kg (34 lb) Ductile Iron 26 kg (57 lb)
Air Inlet	316 Stainless Steel 28 kg (61 lb)
Inlet	13 mm (1/2")
Outlet	25 mm (1")
Suction Lift	25 mm (1") 5.9 m Dry (19.3') 9.0 m Wet (29.5')
Disp. Per Stroke	0.30 L (0.08 gal)
Max. Flow Rate	212 lpm (56 gpm)
Max. Size Solids	6.4 mm (1/4")

¹Displacement per stroke was calculated at 4.8 bar (70 psig) air inlet pressure against a 2.1 bar (30 psig) head pressure.

The Efficiency Management System (EMS) can be used to optimize the performance of your Wilden pump for specific applications. The pump is delivered with the EMS adjusted to setting 4, which allows maximum flow.

The EMS curve allows the pump user to determine flow and air consumption at each EMS setting. For any EMS setting and discharge pressure, the X factor is used as a multiplier with the original values from the setting 4 performance curve to calculate the actual flow and air consumption values for that specific EMS setting. Note: You can interpolate between the setting curves for operation at intermediate EMS settings.

EXAMPLE

A PX200 metal, rubber-fitted pump operating at EMS setting 4 achieved a flow rate of 87 lpm (23 gpm) using 49 Nm³/h (29 scfm) of air when run at 5.5 bar (80 psig) air inlet pressure and 4.1 bar (60 psig) discharge pressure (see dot on performance curve).

The end user did not require that much flow and wanted to reduce air consumption at his facility. He determined that EMS setting 3 would meet his needs. At 4.1 bar (60 psig) discharge pressure and EMS setting 3, the flow X factor is 0.86 and the air X factor is 0.74 (see dots on EMS curve).

Multiplying the original setting 4 values by the X factors provides the setting 3 flow rate of 75 lpm (20 gpm) and an air consumption of 36 Nm³/h (21 scfm). The flow rate was reduced by 14% while the air consumption was reduced by 26%, thus providing increased efficiency.

For a detailed example for how to set your EMS, see beginning of performance curve section.

Caution: Do not exceed 8.6 bar (125 psig) air supply pressure. Canadian Standards Association (CSA) configured pumps should not exceed 6.9 bar (100 psig) natural gas supply pressure. Please read all cautions and suggested installation sections before operating any Wilden product.

PX200 METAL TPE-FITTED



SETTING 4 PERFORMANCE CURVE

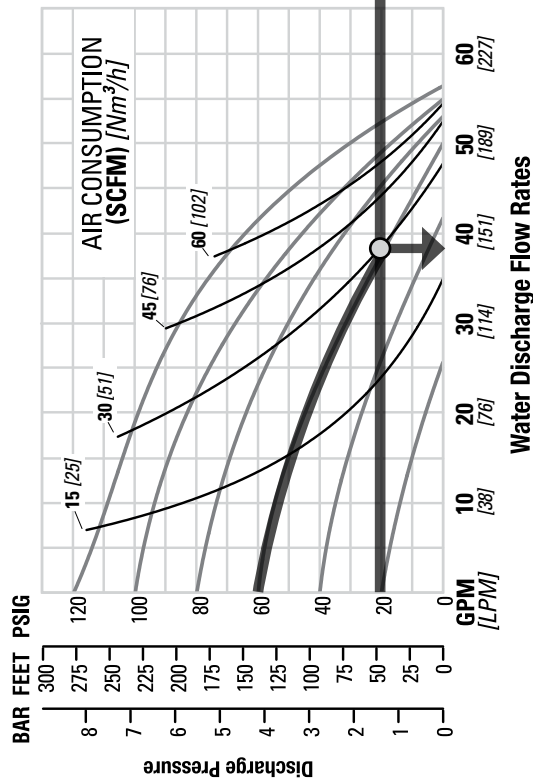

EMS CURVE

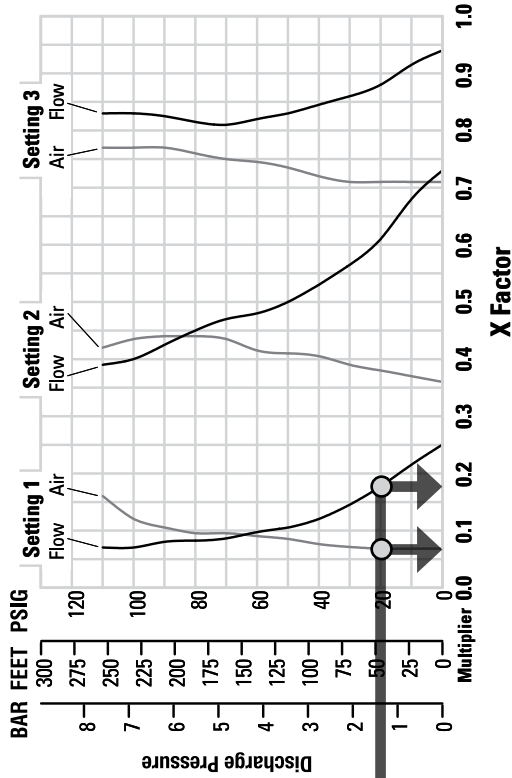

PERFORMANCE



TECHNICAL DATA

Height	340 mm (13.4")
Width	378 mm (14.7")
Depth	244 mm (9.6")
Ship Weight	Aluminum 15 kg (34 lb) Ductile Iron 26 kg (57 lb)
Air Inlet	316 Stainless Steel 28 kg (61 lb)
Inlet	13 mm (1/2")
Outlet	25 mm (1")
Suction Lift	5.5 m Dry (18.2') 9.0 m Wet (29.5')
Disp. Per Stroke	0.34 L (0.09 gal)
Max. Flow Rate	212 lpm (56 gpm)
Max. Size Solids	6.4 mm (1/4")

Displacement per stroke was calculated at 4.8 bar (70 psig) air inlet pressure against a 2.1 bar (30 psig) head pressure

The Efficiency Management System (EMS) can be used to optimize the performance of your Wilden pump for specific applications. The pump is delivered with the EMS adjusted to setting 4 which allows maximum flow.

The EMS curve allows the pump user to determine flow and air consumption at each EMS setting. For any EMS setting and discharge pressure, the X factor is used as a multiplier with the original values from the setting 4 performance curve to calculate the actual flow and air consumption values for that specific EMS setting. Note: You can interpolate between the setting curves for operation at intermediate EMS settings.

EXAMPLE

A PX200 metal, TPE-fitted pump operating at EMS setting 4 achieved a flow rate of 142 lpm (38 gpm) using 49 Nm³/h (29 scfm) of air when run at 4.1 bar (60 psig) air inlet pressure and 1.4 bar (20 psig) discharge pressure (see dot on performance curve).

The end user did not require that much flow and wanted to reduce air consumption at his facility. He determined that EMS setting 1 would meet his needs. At 1.4 bar (20 psig) discharge pressure and EMS setting 1, the flow X factor is 0.18 and the air X factor is 0.07 (see dots on EMS curve).

Multiplying the original setting 4 values by the X factors provides the setting 1 flow rate of 26 lpm (7 gpm) and an air consumption of 3 Nm³/h (2 scfm). The flow rate was reduced by 82% while the air consumption was reduced by 93%, thus providing increased efficiency.

For a detailed example for how to set your EMS, see beginning of performance curve section.

Caution: Do not exceed 8.6 bar (125 psig) air supply pressure. Canadian Standards Association (CSA) configured pumps should not exceed 6.9 bar (100 psig) natural gas supply pressure. Please read all cautions and suggested installation sections before operating any Wilden product.

PX200 METAL REDUCED-STROKE PTFE-FITTED



PERFORMANCE



SETTING 4 PERFORMANCE CURVE

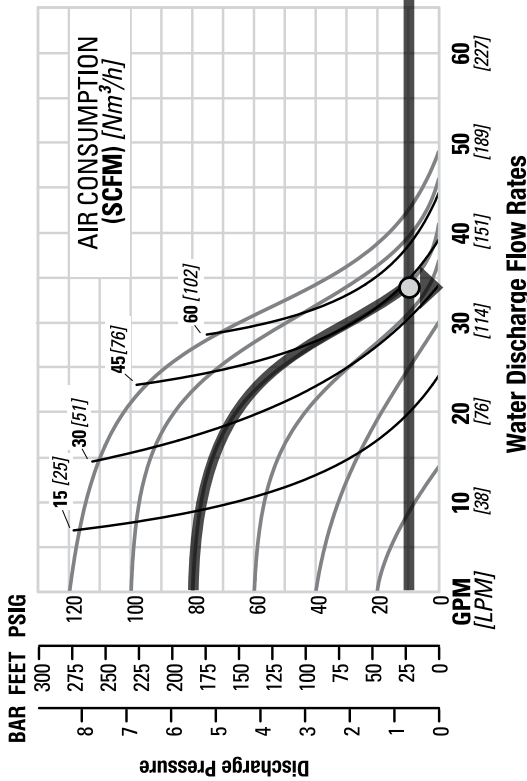

EMS CURVE

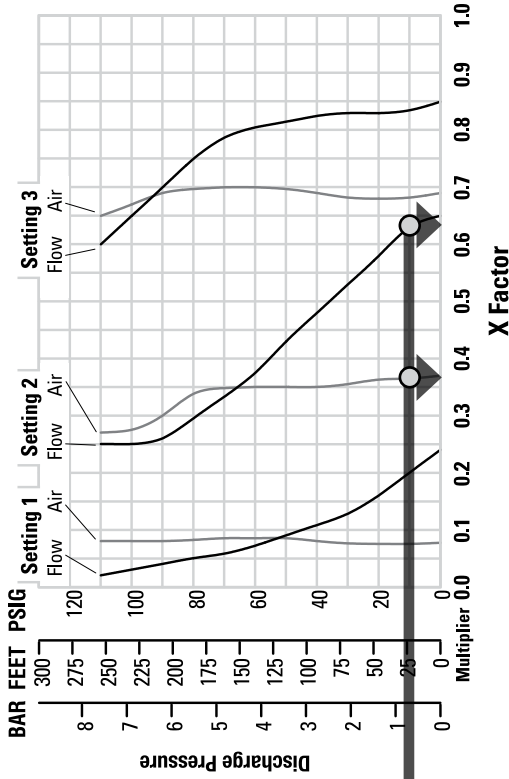

TECHNICAL DATA

Height340 mm (13.4")
Width378 mm (14.7")
Depth244 mm (9.6")
Ship WeightAluminum 15 kg (34 lb)
Ductile Iron 26 kg (57 lb)
316 Stainless Steel 28 kg (61 lb)
Air Inlet13 mm (1/2")
Inlet25 mm (1")
Outlet25 mm (1")
Suction Lift4.3 m Dry (14.2')
9.0 m Wet (29.5')
Disp. Per Stroke0.23 L (0.06 gal) ¹
Max. Flow Rate186 lpm (49 gpm)
Max. Size Solids6.4 mm (1/4")

¹Displacement per stroke was calculated at 4.8 bar (70 psig) air inlet pressure against a 2.1 bar (30 psig) head pressure.

The Efficiency Management System (EMS) can be used to optimize the performance of your Wilden pump for specific applications. The pump is delivered with the EMS adjusted to setting 4 which allows maximum flow.

The EMS curve allows the pump user to determine flow and air consumption at each EMS setting. For any EMS setting and discharge pressure, the X factor is used as a multiplier with the original values from the setting 4 performance curve to calculate the actual flow and air consumption values for that specific EMS setting. Note: You can interpolate between the setting curves for operation at intermediate EMS settings.

EXAMPLE

A PX200 metal, reduced-stroke PTFE-fitted pump operating at EMS setting 4 achieved a flow rate of 129 lpm (34 gpm) using 75 Nm³/h (44 scfm) of air when run at 5.5 bar (80 psig) air inlet pressure and 0.7 bar (10 psig) discharge pressure (see dot on performance curve).

The end user did not require that much flow and wanted to reduce air consumption at his facility. He determined that EMS setting 2 would meet his needs. At 0.7 bar (10 psig) discharge pressure and EMS setting 2, the flow X factor is 0.63 and the air X factor is 0.36 (see dots on EMS curve).

Multiplying the original setting 4 values by the X factors provides the setting 2 flow rate of 81 lpm (21 gpm) and an air consumption of 27 Nm³/h (16 scfm). The flow rate was reduced by 37% while the air consumption was reduced by 64%, thus providing increased efficiency.

For a detailed example for how to set your EMS, see beginning of performance curve section.

Caution: Do not exceed 8.6 bar (125 psig) air supply pressure. Canadian Standards Association (CSA) configured pumps should not exceed 6.9 bar (100 psig) natural gas supply pressure. Please read all cautions and suggested installation sections before operating any Wilden product.

PX200 METAL FULL-STROKE PTFE-FITTED

SETTING 4 PERFORMANCE CURVE

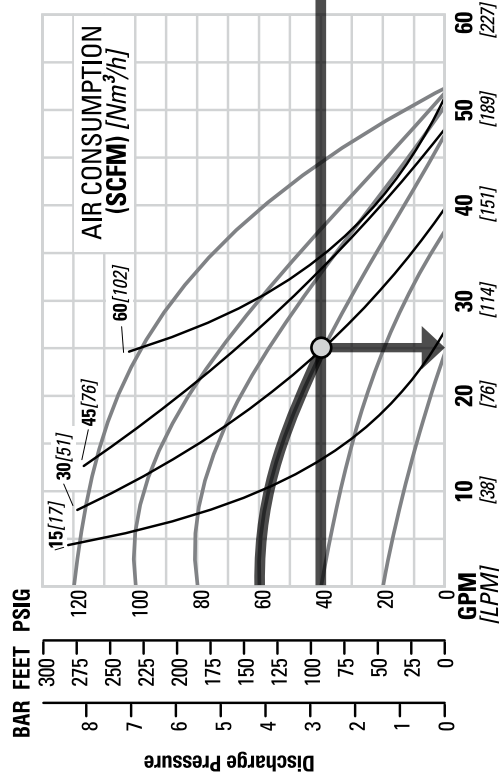

EMS CURVE

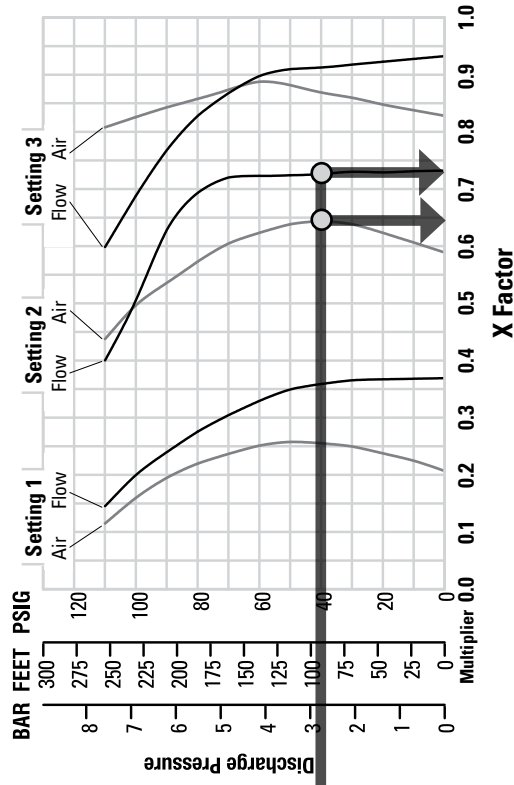

TECHNICAL DATA

Height 340 mm (13.4")
Width 378 mm (14.7")
Depth 244 mm (9.6")
Ship Weight Stainless Steel 28 kg (61 lb)
 Aluminum 15 kg (34 lb)
 Cast Iron 26 kg (57 lb)
Air Inlet 13 mm (1/2")
Inlet 25 mm (1")
Outlet 25 mm (1")
Suction Lift 5.5 m Dry (18.2')
 9.0 m Wet (29.5')
Disp. Per Stroke 0.4 L (0.11 gal)
Max. Flow Rate 198 lpm (52.3 gpm)
Max. Size Solids 6.4 mm (1/4")

¹Displacement per stroke was calculated at 4.8 bar (70 psig) air inlet pressure against a 2.1 bar (30 psig) head pressure.

The Efficiency Management System (EMS) can be used to optimize the performance of your Wilden pump for specific applications. The pump is delivered with the EMS adjusted to setting 4 which allows maximum flow.

The EMS curve allows the pump user to determine flow and air consumption at each EMS setting. For any EMS setting and discharge pressure, the X factor is used as a multiplier with the original values from the setting 4 performance curve to calculate the actual flow and air consumption values for that specific EMS setting. Note: You can interpolate between the setting curves for operation at intermediate EMS settings.

EXAMPLE

A PX200 metal, full-stroke PTFE fitted pump operating at EMS setting 4 achieved a flow rate of 95 lpm (25 gpm) using 51 Nm³/h (30 scfm) of air when run at 4.1 bar (60 psig) air inlet pressure and 2.8 bar (40 psig) discharge pressure (see dot on performance curve).

The end user did not require that much flow and wanted to reduce air consumption at his facility. He determined that EMS setting 2 would meet his needs. At 2.8 bar (40 psig) discharge pressure and EMS setting 2, the flow X factor is 0.73 and the air X factor is 0.64 (see dots on EMS curve).

Multiplying the original setting 4 values by the X factors provides the setting 2 flow rate of 69 lpm (18 gpm) and an air consumption of 33 Nm³/h (19 scfm). The flow rate was reduced by 27% while the air consumption was reduced by 36%, thus providing increased efficiency.

For a detailed example for how to set your EMS, see beginning of performance curve section.

Caution: Do not exceed 8.6 bar (125 psig) air supply pressure. Canadian Standards Association (CSA) configured pumps should not exceed 6.9 bar (100 psig) natural gas supply pressure. Please read all cautions and suggested installation sections before operating any Wilden product.

SUCTION-LIFT CURVE

**PX200 ADVANCED™
METAL SUCTION-LIFT
CAPABILITY**

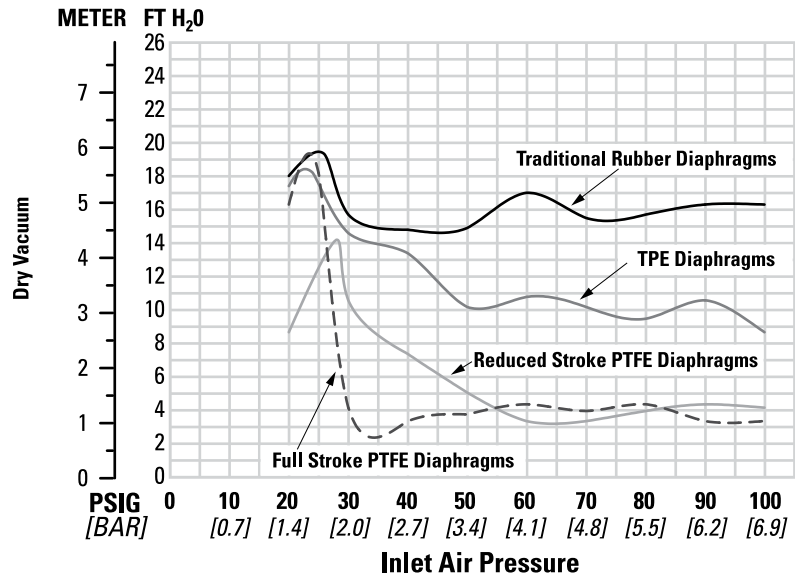

NOTES

SUGGESTED INSTALLATION

Wilden® pumps are designed to meet the performance requirements of even the most demanding pumping applications. They have been designed and manufactured to the highest standards and are available in a variety of liquid path materials to meet your chemical resistance needs. Refer to the performance section of this manual for an in-depth analysis of the performance characteristics of your pump. Wilden offers the widest variety of elastomer options in the industry to satisfy temperature, chemical compatibility, abrasion resistance and flex concerns.

The suction pipe size should be at least the equivalent or larger than the diameter size of the suction inlet on your Wilden pump. The suction hose must be non-collapsible, reinforced type as these pumps are capable of pulling a high vacuum. Discharge piping should also be the equivalent or larger than the diameter of the pump discharge which will help reduce friction losses. It is critical that all fittings and connections are airtight or a reduction or loss of pump suction capability will result.

INSTALLATION: Months of careful planning, study and selection efforts can result in unsatisfactory pump performance if installation details are left to chance.

Premature failure and long-term dissatisfaction can be avoided if reasonable care is exercised throughout the installation process.

LOCATION: Noise, safety and other logistical factors usually dictate where equipment will be situated on the production floor. Multiple installations with conflicting requirements can result in congestion of utility areas, leaving few choices for additional pumps.

Within the framework of these and other existing conditions, every pump should be located in such a way that six key factors are balanced against each other to maximum advantage.

ACCESS: First of all, the location should be accessible. If it's easy to reach the pump, maintenance personnel will have an easier time carrying out routine inspections and adjustments. Should major repairs become necessary, ease of access can play a key role in speeding the repair process and reducing total downtime.

AIR SUPPLY: Every pump location should have an air line large enough to supply the volume of air necessary to achieve the desired pumping rate. Use air pressure up to a maximum of 8.6 bar (125 psig) depending on pumping requirements.

For best results, the pumps should use a 5µ (micron) air filter, needle valve and regulator. The use of an air filter before the pump will ensure that the majority of any pipeline contaminants will be eliminated.

NOTE: Canadian Standards Association (CSA) configured pumps should not exceed 6.9 bar (100 psig) natural gas supply pressure. Only CSA configured pumps should be operated using natural gas.

SOLENOID OPERATION: When operation is controlled by a solenoid valve in the air line, three-way valves should be used. This valve allows trapped air between the valve and the pump to bleed off which improves pump performance. Pumping volume can be estimated by counting the number of strokes per minute and then multiplying the figure by the displacement per stroke.

MUFFLER: Sound levels are reduced below OSHA specifications using the standard Wilden muffler. Other mufflers can be used to further reduce sound levels, but they usually reduce pump performance.

ELEVATION: Selecting a site that is well within the pump's dynamic lift capability will assure that loss-of-prime issues will be eliminated. In addition, pump efficiency can be adversely affected if proper attention is not given to site location.

PIPING: Final determination of the pump site should not be made until the piping challenges of each possible location have been evaluated. The impact of current and future installations should be considered ahead of time to make sure that inadvertent restrictions are not created for any remaining sites.

For U.L. listed pumps, all installation must conform with NFPA 30, NFPA 30A and other applicable codes. All pipe connections are to be made using U.L. classified gasoline-resistant pipe compound. Exhaust port is to be connected to pipe or tubing to be routed outdoors or other location determined to be equivalent.

The best choice possible will be a site involving the shortest and straightest hook-up of suction and discharge piping. Unnecessary elbows, bends and fittings should be avoided. Pipe sizes should be selected to keep friction losses within practical limits. All piping should be supported independently of the pump. In addition, the piping should be aligned to avoid placing stress on the pump fittings.

Flexible hose can be installed to aid in absorbing the forces created by the natural reciprocating action of the pump. If the pump is to be bolted down to a solid location, a mounting pad placed between the pump and the foundation will assist in minimizing pump vibration. Flexible connections between the pump and rigid piping will also assist in minimizing pump vibration. If quick-closing valves are installed at any point in the discharge system, or if pulsation within a system becomes a problem, a surge suppressor (SD Equalizer®) should be installed to protect the pump, piping and gauges from surges and water hammer.

If the pump is to be used in a self-priming application, make sure that all connections are airtight and that the suction lift is within the model's ability. **Note:** Materials of construction and elastomer material have an effect on suction-lift parameters. Please refer to the performance section for specifics.

When pumps are installed in applications involving flooded suction or suction head pressures, a gate valve should be installed in the suction line to permit closing of the line for pump service.

Pumps in service with a positive suction head are most efficient when inlet pressure is limited to 0.5–0.7 bar (7–10 psig). Premature diaphragm failure may occur if positive suction is 0.7 bar (10 psig) and higher.

SUBMERSIBLE APPLICATIONS: Pro-Flo X™ pumps can be used for submersible applications when using the Pro-Flo X™ submersible option. Turbo-Flo™ pumps can also be used for submersible applications when using the Turbo-Flo™ submersible option.

NOTE: Pro-Flo® and Accu-Flo™ pumps are not submersible.

ALL WILDEN PUMPS ARE CAPABLE OF PASSING SOLIDS. A STRAINER SHOULD BE USED ON THE PUMP INTAKE TO ENSURE THAT THE PUMP'S RATED SOLIDS CAPACITY IS NOT EXCEEDED.

CAUTION: DO NOT EXCEED 8.6 BAR (125 PSIG) AIR SUPPLY PRESSURE.

CAUTION: CANADIAN STANDARDS ASSOCIATION (CSA) CONFIGURED PUMPS SHOULD NOT EXCEED 6.9 BAR (100PSIG) NATURAL GAS SUPPLY PRESSURE.

CAUTION: FOR U.L. LISTED PUMPS, DO NOT EXCEED 3.4 BAR (50 PSIG) AIR SUPPLY PRESSURE.

This illustration is a generic representation of an air-operated double-diaphragm pump.

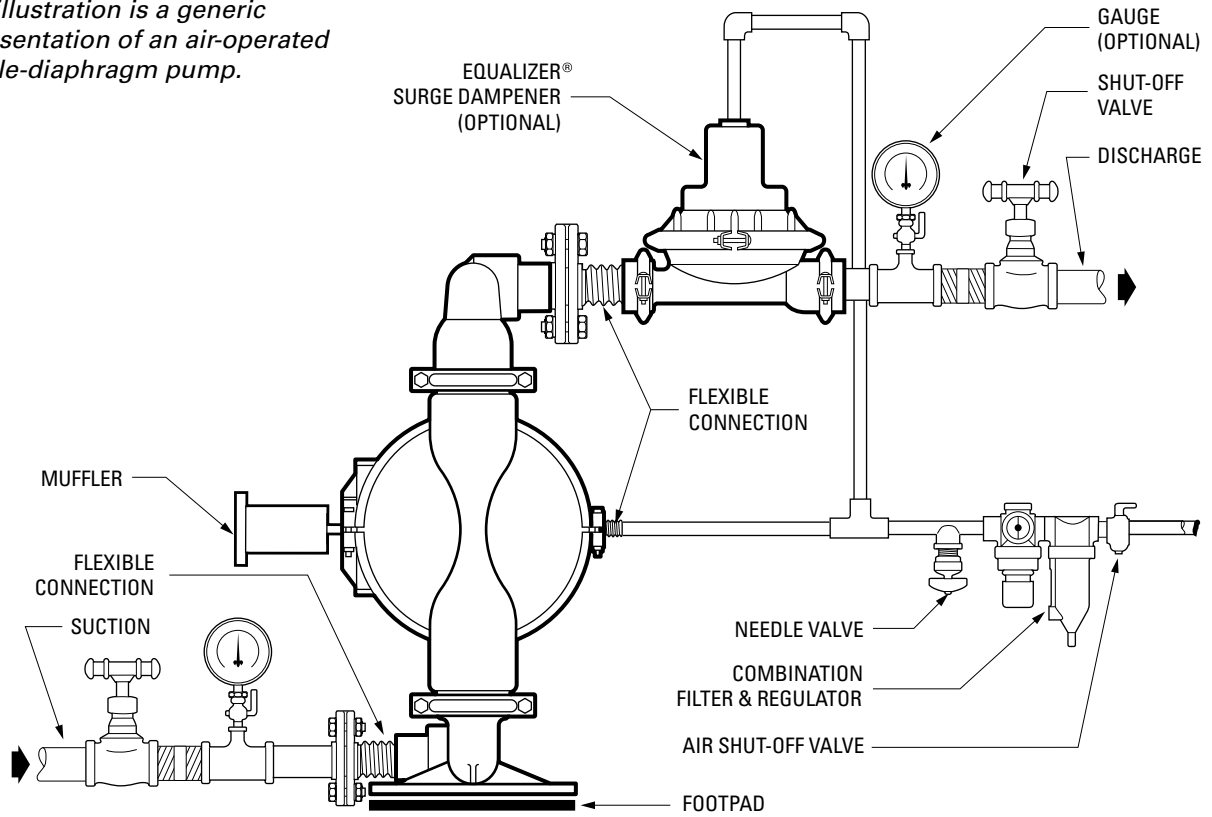

NOTE: In the event of a power failure, the shut-off valve should be closed, if the restarting of the pump is not desirable once power is regained.

AIR-OPERATED PUMPS: To stop the pump from operating in an emergency situation, simply close the

shut-off valve (user supplied) installed in the air supply line. A properly functioning valve will stop the air supply to the pump, therefore stopping output. This shut-off valve should be located far enough away from the pumping equipment such that it can be reached safely in an emergency situation.

SUGGESTED OPERATION & MAINTENANCE

OPERATION: The Pro-Flo® and Pro-Flo X™ pumps are pre-lubricated and do not require in-line lubrication. Additional lubrication will not damage the pump, however if the pump is heavily lubricated by an external source, the pump's internal lubrication may be washed away. If the pump is then moved to a non-lubricated location, it may need to be disassembled and re-lubricated as described in the ASSEMBLY/DISASSEMBLY INSTRUCTIONS.

Pump discharge rate can be controlled by limiting the volume and/or pressure of the air supply to the pump. A regulator is used to control air pressure while a needle valve is used to control volume. Pump discharge rate can also be controlled by throttling the pump discharge by partially closing a valve in the discharge line of the pump. This action increases friction loss which reduces flow rate. (See Section 5.) This is useful when the need exists to control the pump from a remote location. When the pump discharge pressure equals or exceeds the air supply pressure, the pump will stop; no bypass or pressure relief valve is needed, and pump damage will not occur. The pump has reached a "deadhead"

situation and can be restarted by reducing the fluid discharge pressure or increasing the air inlet pressure. The Pro-Flo® and Pro-Flo X™ pumps run solely on compressed air and do not generate heat, therefore your process fluid temperature will not be affected.

MAINTENANCE AND INSPECTIONS: Since each application is unique, maintenance schedules may be different for every pump. Frequency of use, line pressure, viscosity and abrasiveness of process fluid all affect the parts life of a Wilden pump. Periodic inspections have been found to offer the best means for preventing unscheduled pump downtime. Personnel familiar with the pump's construction and service should be informed of any abnormalities that are detected during operation.

RECORDS: When service is required, a record should be made of all necessary repairs and replacements. Over a period of time, such records can become a valuable tool for predicting and preventing future maintenance problems and unscheduled downtime. In addition, accurate records make it possible to identify pumps that are poorly suited to their applications.

TROUBLESHOOTING

Pump will not run or runs slowly.

1. Ensure that the air inlet pressure is at least 0.3 bar (5 psig) above startup pressure and that the differential pressure (the difference between air inlet and liquid discharge pressures) is not less than 0.7 bar (10 psig).
2. Check air inlet filter for debris (see SUGGESTED INSTALLATION).
3. Check for extreme air leakage (blow by) which would indicate worn seals/bores in the air valve, pilot spool and main shaft.
4. Disassemble pump and check for obstructions in the air passageways or objects which would obstruct the movement of internal parts.
5. Check for sticking ball check valves. If material being pumped is not compatible with pump elastomers, swelling may occur. Replace ball check valves and seals with proper elastomers. Also, as the check valve balls wear out, they become smaller and can become stuck in the seats. In this case, replace balls and seats.
6. Check for broken inner piston which will cause the air valve spool to be unable to shift.
7. Remove plug from pilot spool exhaust.

Pump runs but little or no product flows.

1. Check for pump cavitation; slow pump speed down to allow thick material to flow into liquid chambers.

2. Verify that vacuum required to lift liquid is not greater than the vapor pressure of the material being pumped (cavitation).
3. Check for sticking ball check valves. If material being pumped is not compatible with pump elastomers, swelling may occur. Replace ball check valves and seats with proper elastomers. Also, as the check valve balls wear out, they become smaller and can become stuck in the seats. In this case, replace balls and seats.

Pump air valve freezes.

1. Check for excessive moisture in compressed air. Either install a dryer or hot air generator for compressed air. Alternatively, a coalescing filter may be used to remove the water from the compressed air in some applications.

Air bubbles in pump discharge.

1. Check for ruptured diaphragm.
2. Check tightness of outer pistons (refer to Section 7).
3. Check tightness of fasteners and integrity of O-rings and seals, especially at intake manifold.
4. Ensure pipe connections are airtight.

Product comes out air exhaust.

1. Check for diaphragm rupture.
2. Check tightness of outer pistons to shaft.

PUMP DISASSEMBLY

Tools Required:

- 13 mm (1/2") Box Wrench
- 2 – 25 mm (1") Sockets or Adjustable Wrench
- Adjustable Wrench
- Vise equipped with soft jaws (such as plywood, plastic or other suitable material)

CAUTION: Before any maintenance or repair is attempted, the compressed air line to the pump should be disconnected and all air pressure allowed to bleed from the pump. Disconnect all intake, discharge and air lines. Drain the pump by turning it upside down and allowing any fluid to flow into a suitable container. Be aware of any hazardous effects of contact with your process fluid.

NOTE: The model used for these instructions incorporates rubber diaphragms and balls. Models with PTFE diaphragms and balls are the same except where noted.

**Step 1**

Please note alignment marks on center section. Use to properly align liquid chamber to center section.

**Step 2**

Using a 13 mm (1/2") wrench, loosen the discharge manifold from the liquid chambers.

**Step 3**

Remove the discharge manifold to expose the valve balls, valve seats and valve seat O-rings.



Step 4

Remove the discharge valve balls, seats and valve seat O-rings from the discharge manifold and liquid chamber, inspect for nicks, gouges, chemical attack or abrasive wear. **NOTE:** Replace worn parts with genuine Wilden part for reliable performance.



Step 5

Using a 13 mm (1/2") wrench, remove the inlet manifold.

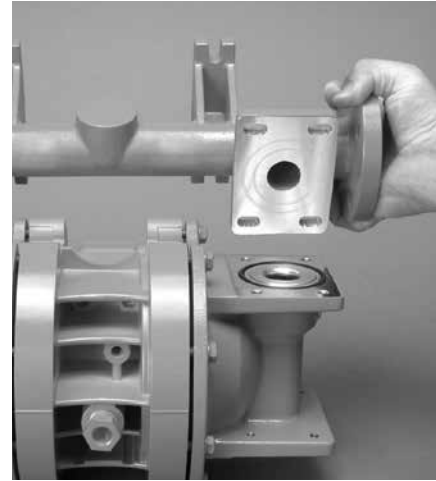

Step 6

Remove the inlet valve balls, seats and valve seat O-rings from the liquid chamber and inlet manifold, inspect for nicks, gouges, chemical attack or abrasive wear.

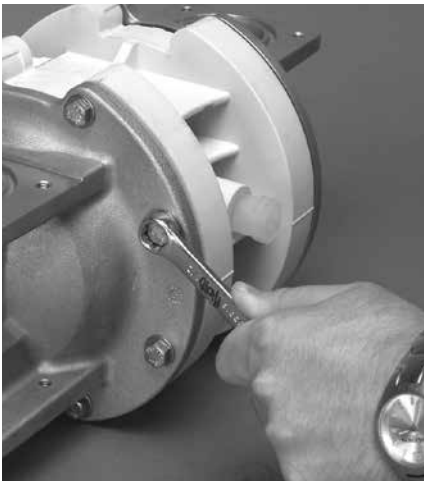

Step 7

Using a 13 mm (1/2") wrench, remove the liquid chambers from the center section.



Step 8

The liquid chamber should be removed to expose the diaphragm and outer piston. Rotate center section and remove the opposite liquid chamber.



Step 9

Using two adjustable wrenches or 25 mm (1") sockets, remove diaphragm assembly from center section assembly.



Step 10

After loosening and removing the outer piston the diaphragm assembly can be disassembled.



Step 11

To remove the remaining diaphragm assembly from the shaft, secure shaft with soft jaws (a vise fitted with plywood or other suitable material) to ensure shaft is not nicked, scratched, or gouged. Using an adjustable wrench, remove diaphragm assembly from shaft. Inspect all parts for wear and replace with genuine Wilden parts if necessary.



Step 12

Inspect diaphragms, outer and inner pistons for signs of wear. Replace with genuine Wilden parts if necessary.

GROUNDING STRAP FOR CSA PX200 PUMPS

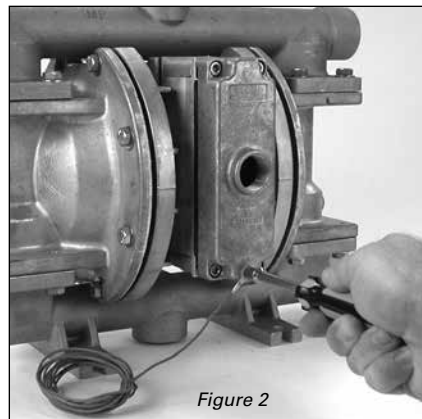
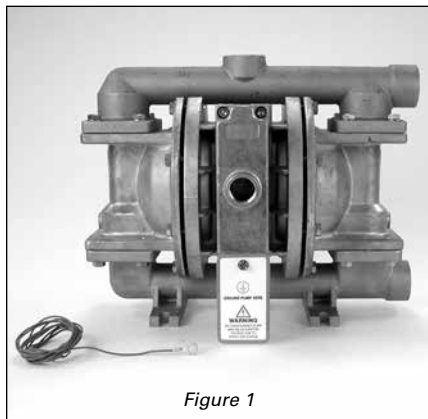

Canadian Standards Association (CSA) configured pumps must be electrically grounded using the grounding strap provided (Figure 1). Improper grounding can cause improper and dangerous operation. To properly attach the grounding strap to a CSA configured PX200 pump, identify the designated grounding location on the muffer plate; using the provided self-tapping screw and grounding wire, thread the grounding screw through the grounding wire lug, into the muffer plate and tighten securely (figure 2). Completion of the pump grounding procedure must be done in accordance with local codes, or in the absence of local codes, an industrial or nationally recognized code having jurisdiction over the specified installation.

AIR VALVE DISASSEMBLY

Tools Required:

- 5 mm (3/16") Allen Wrench
- Snap Ring Pliers
- O-Ring Pick

CAUTION: Before any maintenance or repair is attempted, the compressed air line to the pump should be disconnected and all air pressure allowed to bleed from the pump. Disconnect all intake, discharge and air lines. Drain the pump by turning it upside down and allowing any fluid to flow into a suitable container. Be aware of hazardous effects of contact with your process fluid.

The Wilden P200 Advanced™ metal pump uses the revolutionary Pro-Flo® air distribution system. The PX200 Advanced™ metal pump uses the Pro-Flo X™ air distribution system. A 6 mm (1/4") air inlet connects the air supply to the center section. Proprietary composite seals reduce the coefficient of friction and allow the P200 to run lube-free. Constructed of polypropylene, the Pro-Flo® air distribution system is designed to perform in on/off, non-freezing, non-stalling, tough duty applications.



Step 1

Loosen the air valve bolts utilizing a 5 mm (3/16") Allen wrench.

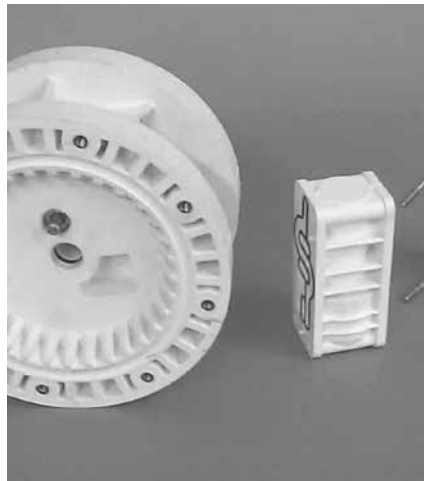

Step 2

Remove muffler plate and air valve bolts from air valve assembly exposing muffler gasket for inspection. Replace if necessary.



Step 3

Lift away air valve assembly and remove air valve gasket for inspection. Replace if necessary.



Step 4

Remove air valve end cap to expose air valve spool by simply lifting up on end cap once air valve bolts are removed.



Step 5

Remove air valve spool from air valve body by threading one air valve bolt into the end of the spool and gently sliding the spool out of the air valve body. Inspect seals for signs of wear and replace entire assembly if necessary. Use caution when handling air valve spool to prevent damaging seals.

NOTE: Seals should not be removed from assembly. Seals are not sold separately.



Step 6

Remove pilot spool sleeve retaining snap ring on both sides of center section with snap ring pliers.

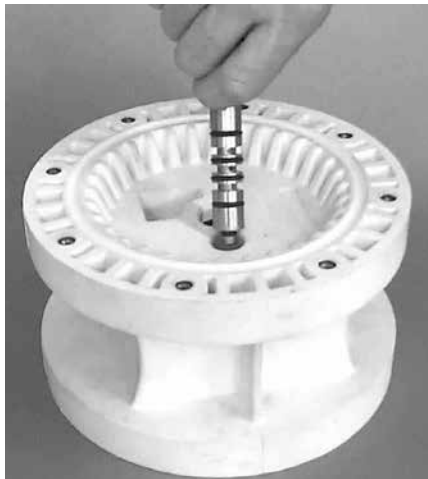

Step 7

Remove pilot spool sleeve from center section.



Step 8

With O-ring pick, gently remove the O-ring from the opposite side of the center hole cut on the spool. Gently remove the pilot spool from sleeve and inspect for nicks, gouges or other signs of wear. Replace pilot sleeve assembly or outer sleeve O-rings if necessary. During reassembly never insert the pilot spool into the sleeve with the center cut side first, this end incorporates the urethane O-ring and will be damaged as it slides over the ports cut in the sleeve.

NOTE: Seals should not be removed from pilot spool. Seals are not sold separately.

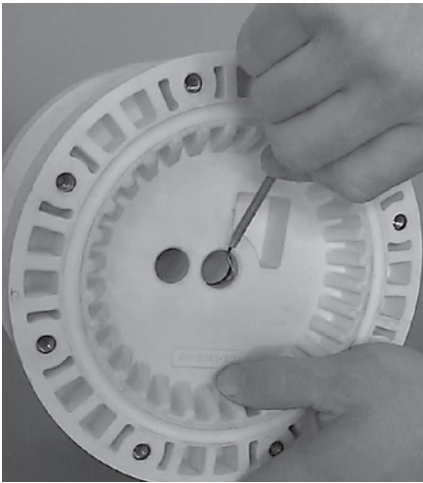

Step 9

Check center section Glyd™ rings for signs of wear. If necessary, remove Glyd™ rings with O-ring pick and replace.

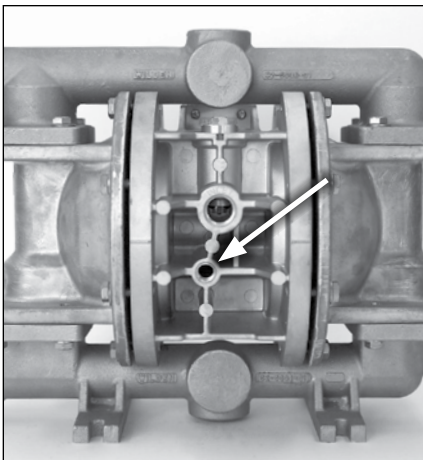

Step 1

Install a 1/4" NPT pipe plug (00-7010-08 or 00-7010-03) into the pilot spool bleed port located at the front of the center section.

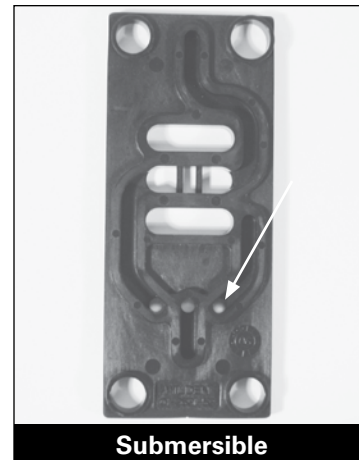
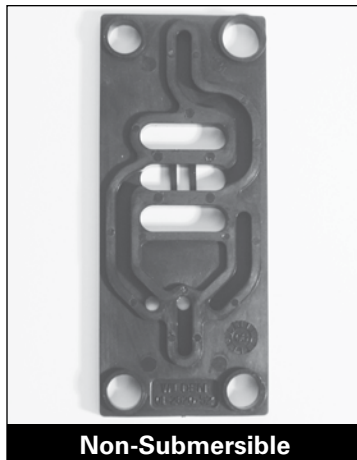

Step 2

Next, install an optional submersible air valve gasket (02-2621-52). The submersible air valve gasket can be purchased as a spare part or included with the purchase of a new Pro-Flo X™ pump.

ASSEMBLY:

Upon performing applicable maintenance to the air distribution system, the pump can now be reassembled. Please refer to the disassembly instructions for photos and parts placement. To reassemble the pump, follow the disassembly instructions in reverse order. The air distribution system needs to be assembled first, then the diaphragms and finally the wetted path. Please find the applicable torque specifications on this page. The following tips will assist in the assembly process.

- Lubricate air valve bore, center section shaft and pilot spool bore with NLGI grade 2 white EP bearing grease or equivalent.
- Clean the inside of the center section shaft bore to ensure no damage is done to new shaft seals.
- A small amount of NLGI grade 2 white EP bearing grease can be applied to the muffler and air valve gaskets to locate gaskets during assembly.
- Make sure that the exhaust port on the muffler plate is centered between the two exhaust ports on the center section.
- Stainless bolts should be lubed to reduce the possibility of seizing during tightening.

PRO-FLO[®] MAXIMUM TORQUE SPECIFICATIONS

Description of Part	Torque
Air Valve	3.1 N•m (27 in-lb)
Outer Pistons, All Diaphragms	40.7 N•m (30 ft-lb)
Top and Bottom Manifold	8.5 N•m (75 in-lb)
Liquid Chamber to Center Section	8.5 N•m (75 in-lb)

PRO-FLO X[™] MAXIMUM TORQUE SPECIFICATIONS

Description of Part	Torque
Air Valve	11.3 N•m (100 in-lb)
Dial Set Screw	11.3 N•m (100 in-lb)
Outer Pistons, All diaphragms	47.1 N•m (30 ft-lb)
Top and Bottom Manifold	8.5 N•m (75 in-lb)
Liquid Chamber to Center Section	8.5 N•m (75 in-lb)

Figure A

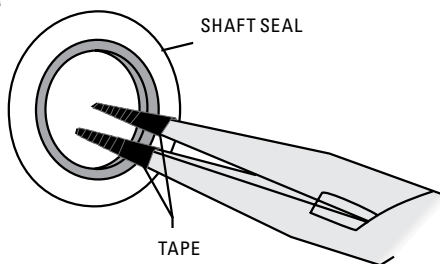

SHAFT SEAL INSTALLATION:

PRE-INSTALLATION

- Once all of the old seals have been removed, the inside of the bushing should be cleaned to ensure no debris is left that may cause premature damage to the new seals.

INSTALLATION

The following tools can be used to aid in the installation of the new seals:

- Needle Nose Pliers
- Phillips Screwdriver
- Electrical Tape

- Wrap electrical tape around each leg of the needle nose pliers (heat shrink tubing may also be used). This is done to prevent damaging the inside surface of the new seal.
- With a new seal in hand, place the two legs of the needle nose pliers inside the seal ring. (See Figure A.)
- Open the pliers as wide as the seal diameter will allow, then with two fingers pull down on the top portion of the seal to form kidney bean shape. (See Figure B.)
- Lightly clamp the pliers together to hold the seal into the kidney shape. Be sure to pull the seal into as tight of a kidney shape as possible, this will allow the seal to travel down the bushing bore easier.
- With the seal clamped in the pliers, insert the seal into the bushing bore and position the bottom of the seal into the correct groove. Once the bottom of the seal is seated in the groove, release the clamp pressure on the pliers. This will allow the seal to partially snap back to its original shape.
- After the pliers are removed, you will notice a slight bump in the seal shape. Before the seal can be properly resized, the bump in the seal should be removed as much as possible. This can be done with either the Phillips screwdriver or your finger. With either the side of the screwdriver or your finger, apply light pressure to the peak of the bump. This pressure will cause the bump to be almost completely eliminated.
- Lubricate the edge of the shaft with NLGI grade 2 white EP bearing grease.
- Slowly insert the center shaft with a rotating motion. This will complete the resizing of the seal.
- Perform these steps for the remaining seals.

Figure B

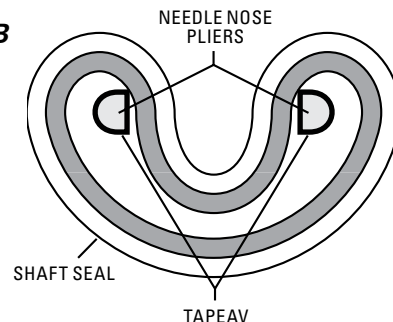

EXPLODED VIEW & PARTS LISTING

P200 ADVANCED METAL

Full-Stroke Diaphragm-Fitted

EXPLODED VIEW

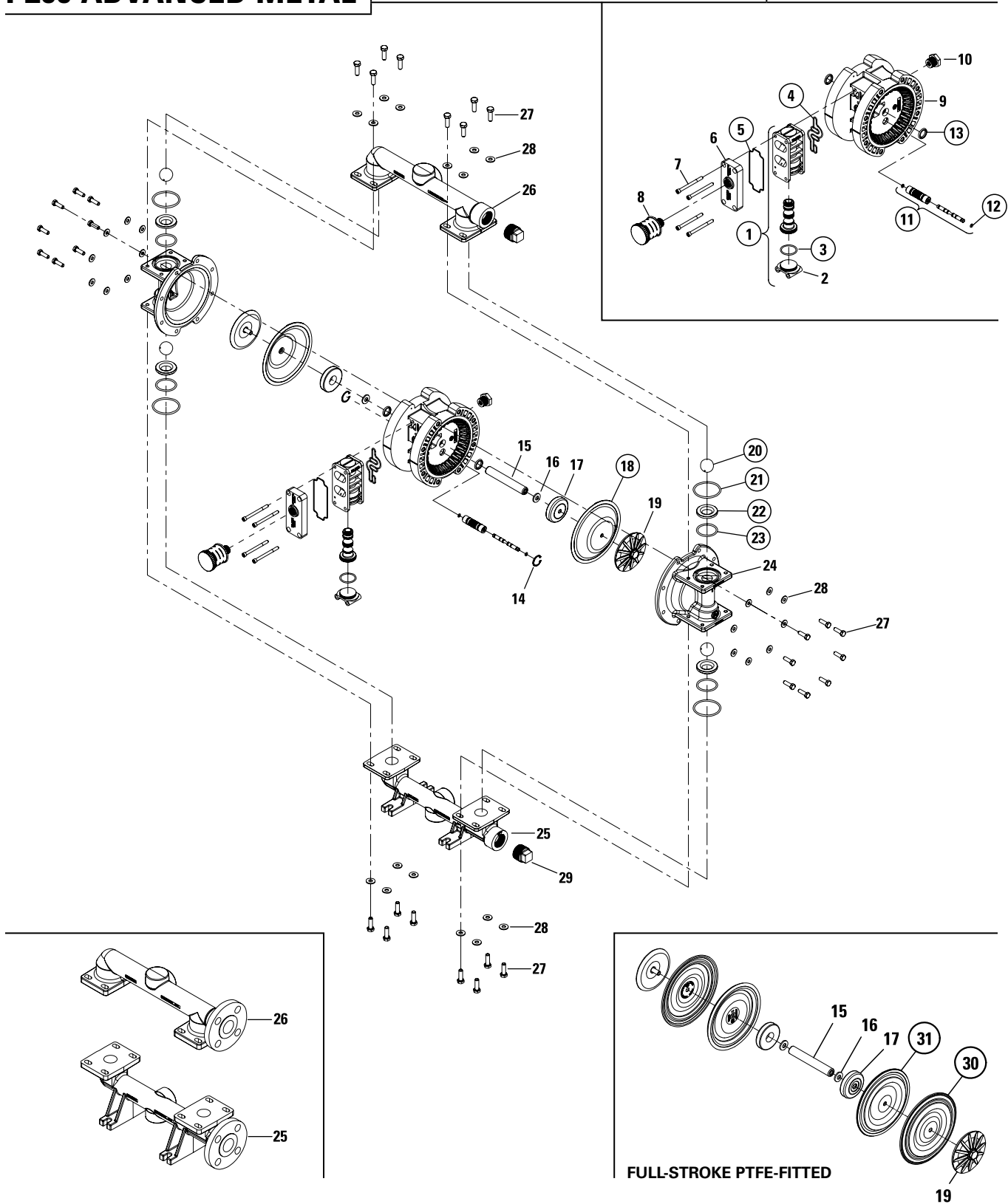

ALL CIRCLED PART IDENTIFIERS ARE INCLUDED IN REPAIR KITS (see Section 9).

EXPLODED VIEW & PARTS LISTING

P200 ADVANCED METAL | Full-Stroke Diaphragm-Fitted | PARTS LISTING

No.	Description	Qty.	P200/AAPPP P/N	P200/WSPPP P/N	P200/SSPPP P/N
1	Pro-Flo® Air Valve Assembly¹	1	01-2010-20	01-2010-20	01-2010-20
2	End Cap	1	01-2332-20	01-2332-20	01-2332-20
3	End Cap O-ring	1	01-2395-52	01-2395-52	01-2395-52
4	Air Valve Gasket	1	01-2615-52	01-2615-52	01-2615-52
5	Muffler Plate Gasket	1	01-3505-52	01-3505-52	01-3505-52
6	Muffler Plate	1	01-3181-20	01-3181-20	01-3181-20
7	Screw, SHC, 1/4"-20 x 3"	4	01-6001-03	01-6001-03	01-6001-03
8	Muffler	1	02-3510-99	02-3510-99	02-3510-99
9	Center Section	1	02-3142-20	02-3142-20	02-3142-20
10	Reducer Bushing	1	01-6950-20	01-6950-20	01-6950-20
11	Removable Pilot Sleeve Assy.	1	02-3880-99	02-3880-99	02-3880-99
12	Pilot Spool Retaining O-ring	2	04-2650-49-700	04-2650-49-700	04-2650-49-700
13	Shaft Seal	2	02-3210-55-225	02-3210-55-225	02-3210-55-225
14	Retaining Snap Ring	2	00-2650-03	00-2650-03	00-2650-03
15	Shaft	1	02-3810-03	02-3810-03	02-3810-03
16	Disc Spring	2	02-6802-08	02-6802-08	02-6802-08
17	Inner Piston	2	02-3701-01	02-3701-01	02-3701-01
18	Diaphragm	2	*	*	*
19	Outer Piston	2	02-4550-01	02-4550-03	02-4550-03
20	Valve Ball	4	*	*	*
21	Manifold O-ring	4	*	*	*
22	Valve Seat	4	02-1125-01	02-1125-08	02-1125-03
23	Valve Seat O-ring	4	*	*	*
24	Liquid Chamber	2	02-5015-01	02-5015-02	02-5015-03
25	Inlet Manifold, ANSI Flange	1	02-5090-01	02-5090-02	02-5090-03
	Inlet Manifold, DIN Flange	1	02-5091-01	02-5091-02	02-5091-03
	Inlet Manifold, Side Ported, 1" NPT	1	02-5095-01	02-5095-02	02-5095-03
	Inlet Manifold, Side Ported, 1" BSPT	1	02-5096-01	02-5096-02	02-5096-03
	Inlet Manifold, Center Ported, 1" NPT	1	02-5095-01-677	02-5095-02-677	02-5095-03-677
	Inlet Manifold, Center Ported, 1" BSPT	1	02-5096-01-678	02-5096-02-678	02-5096-03-678
26	Discharge Manifold, ANSI Flange	1	02-5030-01	02-5030-02	02-5030-03
	Discharge Manifold, DIN Flange	1	02-5031-01	02-5031-02	02-5031-03
	Discharge Manifold, Side Ported, 1" NPT	1	02-5035-01	02-5035-02	02-5035-03
	Discharge Manifold, Side Ported, 1" BSPT	1	02-5036-01	02-5036-02	02-5036-03
	Discharge Manifold, Center Ported, 3/4" NPT	1	02-5035-01-697	02-5035-02-697	02-5035-03-697
	Discharge Manifold, Center Ported, 3/4" BSPT	1	02-5036-01-698	02-5036-02-698	02-5036-03-698
	Discharge Manifold, Center Ported, 1" NPT	1	02-5035-01-677	02-5035-02-677	02-5035-03-677
	Discharge Manifold, Center Ported, 1" BSPT	1	02-5036-01-678	02-5036-02-678	02-5036-03-678
27	Screw, HHC, 5/16"-18 x 1"	32	08-6180-03-42	08-6180-03-42	08-6180-03-42
28	Washer, 5/16"	32	02-6731-03	02-6731-03	02-6731-03
29	Pipe Plug, 1" NPT	2	02-7010-01	02-7010-02	02-7010-03
	Pipe Plug, 1" BSP	2	02-7011-01	02-7011-02	02-7011-03
30	Diaphragm, Primary Full Stroke PTFE	2	*	*	*
31	Diaphragm, Backup Full Stroke PTFE	2	*	*	*

* Refer to Elastomer Options in Section 9

¹Air Valve Assembly includes items 2 and 3

All boldface items are primary wear parts.

EXPLODED VIEW & PARTS LISTING

P200 ADVANCED METAL

Reduced-Stroke Diaphragm-Fitted

EXPLODED VIEW

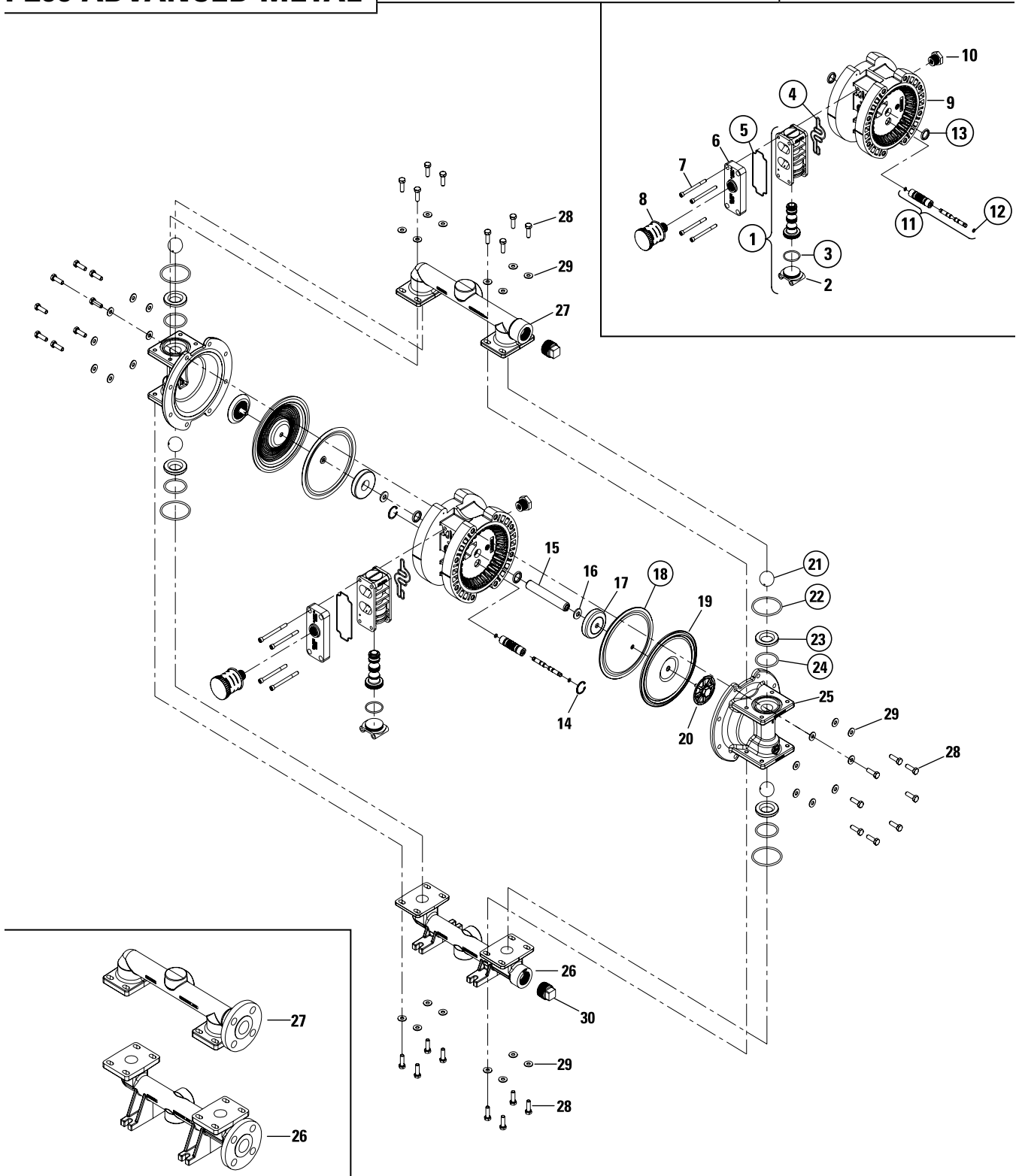

ALL CIRCLED PART IDENTIFIERS ARE INCLUDED IN REPAIR KITS (see Section 9).

P200 ADVANCED METAL

Reduced-Stroke Diaphragm-Fitted

PARTS LISTING

No.	Description	Qty.	P200/AAPPP P/N	P200/WSPPP P/N	P200/SSPPP P/N
1	Pro-Flo® Air Valve Assembly¹	1	01-2010-20	01-2010-20	01-2010-20
2	End Cap	1	01-2332-20	01-2332-20	01-2332-20
3	End Cap O-ring	1	01-2395-52	01-2395-52	01-2395-52
4	Air Valve Gasket	1	01-2615-52	01-2615-52	01-2615-52
5	Muffler Plate Gasket	1	01-3505-52	01-3505-52	01-3505-52
6	Muffler Plate	1	01-3181-20	01-3181-20	01-3181-20
7	Screw, SHC, 1/4"-20 x 3"	4	01-6001-03	01-6001-03	01-6001-03
8	Muffler	1	02-3510-99	02-3510-99	02-3510-99
9	Center Section	1	02-3142-20	02-3142-20	02-3142-20
10	Reducer Bushing	1	01-6950-20	01-6950-20	01-6950-20
11	Removable Pilot Sleeve Assy.	1	02-3880-99	02-3880-99	02-3880-99
12	Pilot Spool Retaining O-ring	2	04-2650-49-700	04-2650-49-700	04-2650-49-700
13	Shaft Seal	2	02-3210-55-225	02-3210-55-225	02-3210-55-225
14	Retaining Snap Ring	2	00-2650-03	00-2650-03	00-2650-03
15	Shaft	1	02-3840-03	02-3840-03	02-3840-03
16	Disc Spring	2	02-6802-08	02-6802-08	02-6802-08
17	Inner Piston	2	02-3751-01	02-3751-01	02-3751-01
18	Back-up Diaphragm	2	*	*	*
19	Diaphragm	2	02-1010-55	02-1010-55	02-1010-55
20	Outer Piston	2	02-4601-01	02-4600-03	02-4600-03
21	Valve Ball	4	02-1085-55	02-1085-55	02-1085-55
22	Manifold O-ring	4	70-1280-55	70-1280-55	70-1280-55
23	Valve Seat	4	02-1125-01	02-1125-08	02-1125-03
24	Valve Seat O-ring	4	02-1205-55	02-1205-55	02-1205-55
25	Liquid Chamber	2	02-5015-01	02-5015-02	02-5015-03
26	Inlet Manifold, ANSI Flange	1	02-5090-01	02-5090-02	02-5090-03
	Inlet Manifold, DIN Flange	1	02-5091-01	02-5091-02	02-5091-03
	Inlet Manifold, Side Ported, 1" NPT	1	02-5095-01	02-5095-02	02-5095-03
	Inlet Manifold, Side Ported, 1" BSPT	1	02-5096-01	02-5096-02	02-5096-03
	Inlet Manifold, Center Ported, 1" NPT	1	02-5095-01-677	02-5095-02-677	02-5095-03-677
	Inlet Manifold, Center Ported, 1" BSPT	1	02-5096-01-678	02-5096-02-678	02-5096-03-678
27	Discharge Manifold, ANSI Flange	1	02-5030-01	02-5030-02	02-5030-03
	Discharge Manifold, DIN Flange	1	02-5031-01	02-5031-02	02-5031-03
	Discharge Manifold, Side Ported, 1" NPT	1	02-5035-01	02-5035-02	02-5035-03
	Discharge Manifold, Side Ported, 1" BSPT	1	02-5036-01	02-5036-02	02-5036-03
	Discharge Manifold, Center Ported, 3/4" NPT	1	02-5035-01-697	02-5035-02-697	02-5035-03-697
	Discharge Manifold, Center Ported, 3/4" BSPT	1	02-5036-01-698	02-5036-02-698	02-5036-03-698
	Discharge Manifold, Center Ported, 1" NPT	1	02-5035-01-677	02-5035-02-677	02-5035-03-677
	Discharge Manifold, Center Ported, 1" BSPT	1	02-5036-01-678	02-5036-02-678	02-5036-03-678
28	Screw, HHC, 5/16"-18 x 1"	32	08-6180-03-42	08-6180-03-42	08-6180-03-42
29	Washer, 5/16"	32	02-6731-03	02-6731-03	02-6731-03
30	Pipe Plug, 1" NPT	2	02-7010-01	02-7010-02	02-7010-03
	Pipe Plug, 1" BSP	2	02-7011-01	02-7011-02	02-7011-03

¹Air Valve Assembly includes items 2 and 3
All boldface items are primary wear parts.

EXPLODED VIEW & PARTS LISTING

PX200 ADVANCED METAL

Full-Stroke Diaphragm-Fitted

EXPLODED VIEW

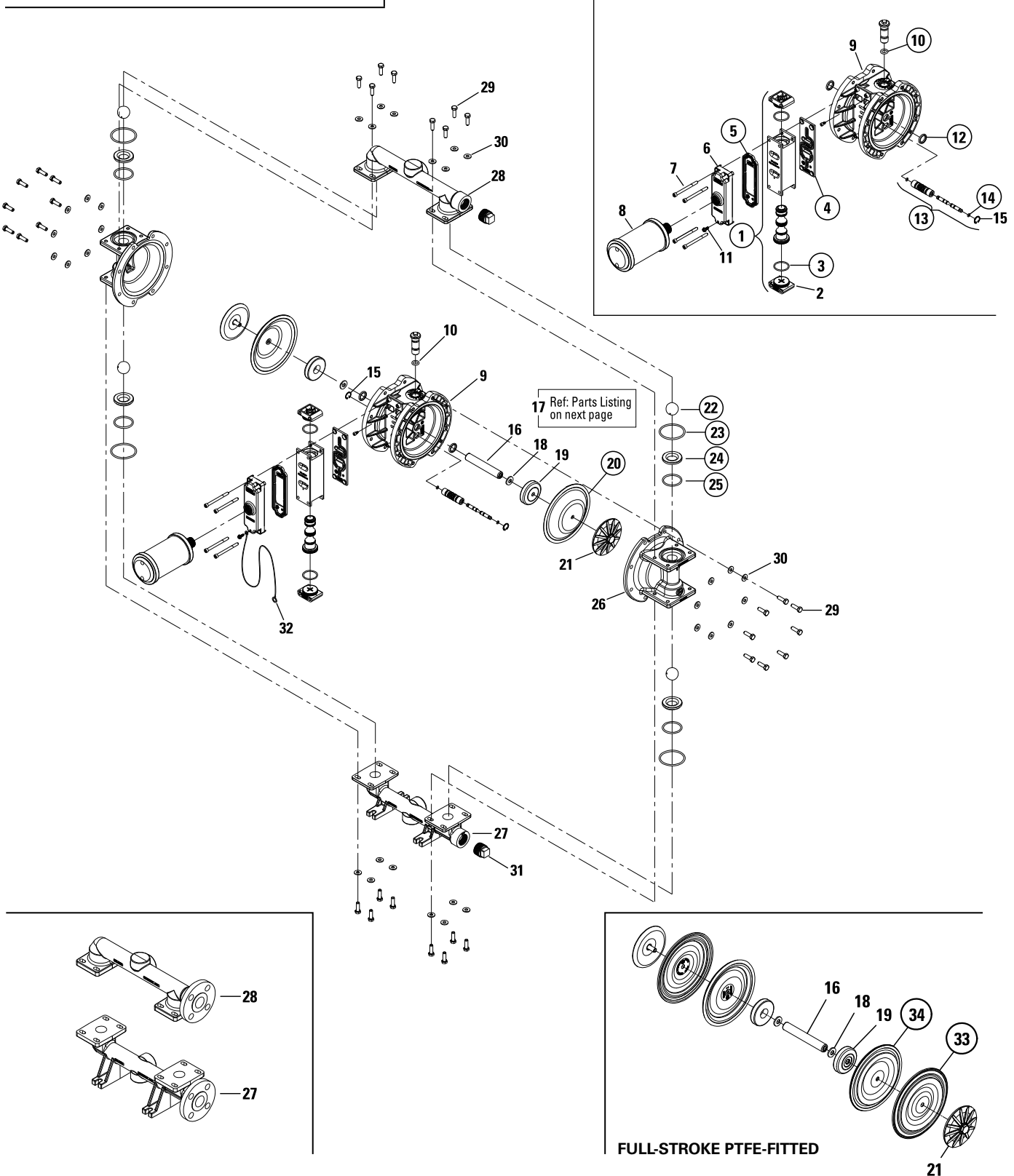

ALL CIRCLED PART IDENTIFIERS ARE INCLUDED IN REPAIR KITS (see Section 9).

PX200 ADVANCED METAL Full-Stroke Diaphragm-Fitted PARTS LISTING

Item	Description	Qty	XPX200/AAAA P/N	XPX200/WWAAA P/N	XPX200/SSAAA P/N
1	Pro-Flo X® Air Valve Assembly¹	1	02-2030-01	02-2030-01	02-2030-01
2	End Cap	2	01-2340-01	01-2340-01	01-2340-01
3	O-Ring (-126), End Cap (Ø1.362 x Ø.103)	2	01-2395-52	01-2395-52	01-2395-52
4	Gasket, Air Valve, Pro-Flo X®	1	02-2620-52	02-2620-52	02-2620-52
5	Gasket, Muffler Plate, Pro-Flo X®	1	02-3502-52	02-3502-52	02-3502-52
6	Muffler Plate, Pro-Flo X®	1	02-3185-01	02-3185-01	02-3185-01
7	Screw, SHC, Air Valve (1/4" -20 x 3")	4	01-6001-03	01-6001-03	01-6001-03
8	Muffler*	1	08-3510-99R	08-3510-99R	08-3510-99R
9	Center Section Assembly, Pro-Flo X® ²	1	02-3148-01	02-3148-01	02-3148-01
10	O-Ring (-206), Air Adjustment Pin (Ø.484 x Ø.139)	1	00-1300-52	00-1300-52	00-1300-52
11	Screw, 10-32 x .50 Self-Tapping Grounding	1	04-6345-08	04-6345-08	04-6345-08
12	Shaft Seal	2	02-3210-55-225	02-3210-55-225	02-3210-55-225
13	Pilot Sleeve Assembly	1	02-3880-99	02-3880-99	02-3880-99
14	Pilot Spool Retaining O-Ring	1	04-2650-49-700	04-2650-49-700	04-2650-49-700
15	Retaining Ring	1	00-2650-03	00-2650-03	00-2650-03
16	Shaft	1	02-3810-03	02-3810-03	02-3810-03
17	Stud, 3/8-16 x 1 1/4" (not shown)	2	N/A	02-6150-08	02-6150-08
18	Disc Spring	2	02-6802-08	02-6802-08	02-6802-08
19	Inner Piston	2	02-3701-01	02-3701-01	02-3701-01
20	Diaphragm	2	*	*	*
21	Outer Piston	2	02-4550-01	02-4550-02	02-4550-03
22	Valve Ball	4	*	*	*
23	Manifold O-ring	4	*	*	*
24	Valve Seat	4	02-1125-01	02-1125-08	02-1125-03
25	Valve Seat O-ring	4	*	*	*
26	Liquid Chamber	2	02-5015-01	02-5015-02	02-5015-03
27	Inlet Manifold, ANSI Flange	1	02-5090-01	02-5090-02	02-5090-03
	Inlet Manifold, DIN Flange	1	02-5091-01	02-5091-02	02-5091-03
	Inlet Manifold, Side Ported, 1" NPT	1	02-5095-01	02-5095-02	02-5095-03
	Inlet Manifold, Side Ported, 1" BSPT	1	02-5096-01	02-5096-02	02-5096-03
	Inlet Manifold, Center Ported, 1" NPT	1	02-5095-01-677	02-5095-02-677	02-5095-03-677
	Inlet Manifold, Center Ported, 1" BSPT	1	02-5096-01-678	02-5096-02-678	02-5096-03-678
28	Discharge Manifold, ANSI Flange	1	02-5030-01	02-5030-02	02-5030-03
	Discharge Manifold, DIN Flange	1	02-5031-01	02-5031-02	02-5031-03
	Discharge Manifold, Side Ported, 1" NPT	1	02-5035-01	02-5035-02	02-5035-03
	Discharge Manifold, Side Ported, 1" BSPT	1	02-5036-01	02-5036-02	02-5036-03
	Discharge Manifold, Center Ported, 3/4" NPT	1	02-5035-01-697	02-5035-02-697	02-5035-03-697
	Discharge Manifold, Center Ported, 3/4" BSPT	1	02-5036-01-698	02-5036-02-698	02-5036-03-698
	Discharge Manifold, Center Ported, 1" NPT	1	02-5035-01-677	02-5035-02-677	02-5035-03-677
	Discharge Manifold, Center Ported, 1" BSPT	1	02-5036-01-678	02-5036-02-678	02-5036-03-678
29	Screw, HHC, 5/16-18 x 1"	32	08-6180-03-42	08-6180-03-42	08-6180-03-42
30	Washer, 5/16	32	02-6731-03	02-6731-03	02-6731-03
31	Pipe Plug, 1" NPT	2	02-7010-01	02-7010-02	02-7010-03
	Pipe Plug, 1" BSPT	2	02-7011-03	02-7011-02	02-7011-03
32	Grounding Strap, CSA ³	1	01-8303-99	01-8303-99	01-8303-99
33	Diaphragm, Primary Full Stroke PTFE	2	02-1040-55	02-1040-55	02-1040-55
34	Diaphragm, Backup Full Stroke PTFE	2	*	*	*

* Refer to Elastomer Options in Section 9

¹Air Valve Assembly includes items numbers 2 and 3

²Center Section Assembly includes items 10, 11 and 12

³CSA pumps to use grounding strap

For submersible Pro-Flo X™ pump, use air valve gasket 01-2621-52 and pipe plug 00-7010-08 or 00-7010-03

All boldface items are primary wear items.

*NOTE: Muffler should not be used with Canadian Standards Association (CSA) pumps. The gas outlet of CSA configured pumps must be vented to a safe location in accordance with local or, in the absence of local codes, an industry or nationally recognized code having jurisdiction over the specified installation.

EXPLODED VIEW & PARTS LISTING

PX200 ADVANCED METAL

Reduced-Stroke Diaphragm-Fitted

EXPLODED VIEW

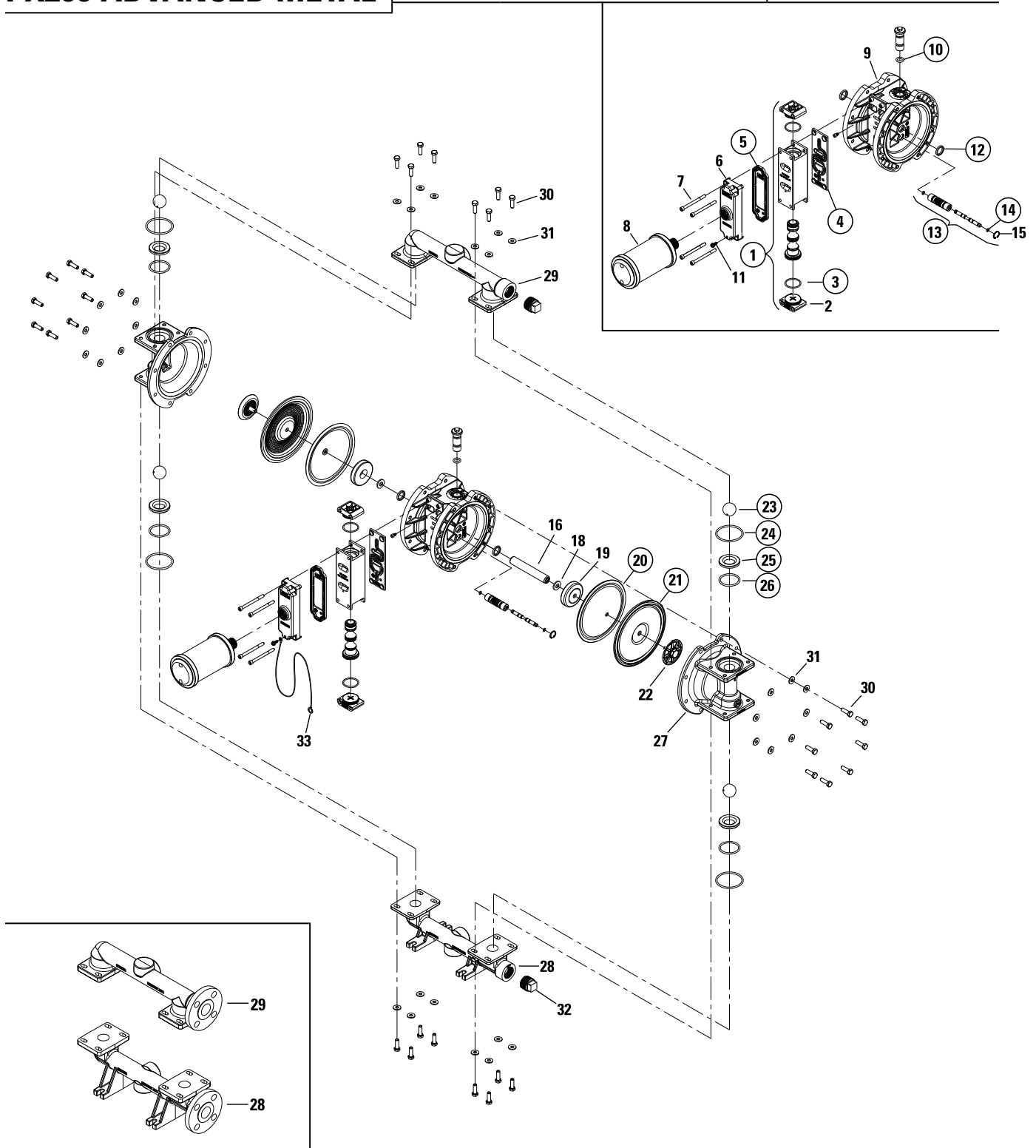

ALL CIRCLED PART IDENTIFIERS ARE INCLUDED IN REPAIR KITS (see Section 9).



EXPLODED VIEW & PARTS LISTING



PX200 ADVANCED METAL | Reduced-Stroke Diaphragm-Fitted | PARTS LISTING

Item	Description	Qty	XPX200/AAAAA P/N	XPX200/WWAAA P/N	XPX200/SSAAA P/N
1	Pro-Flo X® Air Valve Assembly ¹	1	02-2030-01	02-2030-01	02-2030-01
2	End Cap	2	01-2340-01	01-2340-01	01-2340-01
3	O-Ring (-126), End Cap (Ø1.362 x Ø.103)	2	01-2395-52	01-2395-52	01-2395-52
4	Gasket, Air Valve, Pro-Flo X®	1	02-2620-52	02-2620-52	02-2620-52
5	Gasket, Muffler Plate, Pro-Flo X®	1	02-3502-52	02-3502-52	02-3502-52
6	Muffler Plate, Pro-Flo X®	1	02-3185-01	02-3185-01	02-3185-01
7	Screw, SHC, Air Valve (1/4"-20 x 3")	4	01-6001-03	01-6001-03	01-6001-03
8	Muffler*	1	08-3510-99R	08-3510-99R	08-3510-99R
9	Center Section Assembly, Pro-Flo X® ²	1	02-3148-01	02-3148-01	02-3148-01
10	O-Ring (-206), Air Adjustment Pin (Ø.484 x Ø.139)	1	00-1300-52	00-1300-52	00-1300-52
11	Screw, 10-32 x .50 Self-Tapping Grounding	1	04-6345-08	04-6345-08	04-6345-08
12	Shaft Seal	2	02-3210-55-225	02-3210-55-225	02-3210-55-225
13	Pilot Sleeve Assembly	1	02-3880-99	02-3880-99	02-3880-99
14	Pilot Spool Retaining O-Ring	1	04-2650-49-700	04-2650-49-700	04-2650-49-700
15	Retaining Ring	1	00-2650-03	00-2650-03	00-2650-03
16	Shaft	1	02-3840-03	02-3840-03	02-3840-03
17	Stud, 3/8-16 x 1 1/4" (not shown)	2	N/A	02-6150-08	02-6150-08
18	Disc Spring	2	02-6802-08	02-6802-08	02-6802-08
19	Inner Piston	2	02-3751-01	02-3751-01	02-3751-01
20	Back-up Diaphragm	2	*	*	*
21	Diaphragm	2	02-1010-55	02-1010-55	02-1010-55
22	Outer Piston	2	02-4601-01	02-4600-02	02-4600-03
23	Valve Ball	4	02-1085-55	02-1085-55	02-1085-55
24	Manifold O-ring	4	70-1280-55	70-1280-55	70-1280-55
25	Valve Seat	4	02-1125-01	02-1125-08	02-1125-03
26	Valve Seat O-ring	4	02-1205-55	02-1205-55	02-1205-55
27	Liquid Chamber	2	02-5015-01	02-5015-02	02-5015-03
28	Inlet Manifold, ANSI Flange	1	02-5090-01	02-5090-02	02-5090-03
	Inlet Manifold, DIN Flange	1	02-5091-01	02-5091-02	02-5091-03
	Inlet Manifold, Side Ported, 1" NPT	1	02-5095-01	02-5095-02	02-5095-03
	Inlet Manifold, Side Ported, 1" BSPT	1	02-5096-01	02-5096-02	02-5096-03
	Inlet Manifold, Center Ported, 1" NPT	1	02-5095-01-677	02-5095-02-677	02-5095-03-677
	Inlet Manifold, Center Ported, 1" BSPT	1	02-5096-01-678	02-5096-02-678	02-5096-03-678
29	Discharge Manifold, ANSI Flange	1	02-5030-01	02-5030-02	02-5030-03
	Discharge Manifold, DIN Flange	1	02-5031-01	02-5031-02	02-5031-03
	Discharge Manifold, Side Ported, 1" NPT	1	02-5035-01	02-5035-02	02-5035-03
	Discharge Manifold, Side Ported, 1" BSPT	1	02-5036-01	02-5036-02	02-5036-03
	Discharge Manifold, Center Ported, 3/4" NPT	1	02-5035-01-697	02-5035-02-697	02-5035-03-697
	Discharge Manifold, Center Ported, 3/4" BSPT	1	02-5036-01-698	02-5036-02-698	02-5036-03-698
	Discharge Manifold, Center Ported, 1" NPT	1	02-5035-01-677	02-5035-02-677	02-5035-03-677
	Discharge Manifold, Center Ported, 1" BSPT	1	02-5036-01-678	02-5036-02-678	02-5036-03-678
30	Screw, HHC, 5/16-18 x 1"	32	08-6180-03-42	08-6180-03-42	08-6180-03-42
31	Washer, 5/16	32	02-6731-03	02-6731-03	02-6731-03
32	Pipe Plug, 1" NPT	2	02-7010-01	02-7010-02	02-7010-03
	Pipe Plug, 1" BSPT	2	02-7011-03	02-7011-02	02-7011-03
33	Grounding Strap, CSA ³	1	01-8303-99	01-8303-99	01-8303-99

* Refer to Elastomer Options in Section 9

¹Air Valve Assembly includes item numbers 2 and 3

²Center Section Assembly includes items 10, 11 and 12

³CSA pumps to use grounding strap

For submersible Pro-Flo X™ pump, use air valve gasket 01-2621-52 and pipe plug 00-7010-08 or 00-7010-03

All boldface items are primary wear items.

*NOTE: Muffler should not be used with Canadian Standards Association (CSA) pumps. The gas outlet of CSA configured pumps must be vented to a safe location in accordance with local or, in the Absence of local codes, an industry or nationally recognized code having jurisdiction over the specified installation.

ELASTOMER OPTIONS

P200 Advanced™ Metal Pumps

MATERIAL	DIAPHRAGM (2)	REDUCED STROKE BACK-UP DIAPHRAGM (2)	FULL STROKE BACK-UP DIAPHRAGM (2)	VALVE BALL (4)	MANIFOLD O-RING (4)	VALVE SEAT O-RING (4)
Polyurethane	02-1010-50	N/A	N/A	02-1085-50	02-1372-50	02-1205-50
Neoprene	02-1010-51	02-1060-51	N/A	02-1085-51	02-1372-51	02-1205-51
Buna	02-1010-52	N/A	N/A	02-1085-52	70-1280-52	02-1205-52
Viton	02-1010-53	N/A	N/A	02-1085-53	02-1372-53	02-1205-53
EPDM	02-1010-54	02-1060-54	N/A	02-1085-54	02-1372-54	02-1205-54
PTFE	02-1010-55	N/A	N/A	02-1085-55	70-1280-55	02-1205-55
Full Stroke PTFE	02-1040-55	N/A	N/A	02-1085-55	70-1200-55	02-1205-55
Saniflex™	02-1010-56	02-1060-56	02-1065-56	02-1085-56	02-1372-56	02-1205-56
Wil-Flex™	02-1010-58	N/A	02-1065-57	02-1085-58	02-1372-58	02-1205-58

Neoprene and EPDM back-up diaphragms are available upon request. Please consult your local distributor.

ELASTOMER KIT OPTIONS

P200

NEOPRENE	BUNA	VITON	EPDM
02-9572-51	02-9572-52	02-9572-53	02-9572-54

PTFE	FULL STROKE PTFE	WIL-FLEX	SANIFLEX	POLYURETHANE
02-9582-55	Consult Factory	02-9572-58	02-9572-56	02-9572-50

PX200

NEOPRENE	BUNA	VITON	EPDM
02-9582-51	02-9582-52	02-9582-53	02-9582-54

PTFE	FULL STROKE PTFE	WIL-FLEX	SANIFLEX	POLYURETHANE
02-9582-55	Consult Factory	02-9582-58	02-9582-56	02-9582-50

Each and every product manufactured by Wilden Pump and Engineering, LLC is built to meet the highest standards of quality. Every pump is functionally tested to insure integrity of operation.

Wilden Pump and Engineering, LLC warrants that pumps, accessories and parts manufactured or supplied by it to be free from defects in material and workmanship for a period of five (5) years from date of installation or six (6) years from date of manufacture, whichever comes first. Failure due to normal wear, misapplication, or abuse is, of course, excluded from this warranty.

Since the use of Wilden pumps and parts is beyond our control, we cannot guarantee the suitability of any pump or part for a particular application and Wilden Pump and Engineering, LLC shall not be liable for any consequential damage or expense arising from the use or misuse of its products on any application. Responsibility is limited solely to replacement or repair of defective Wilden pumps and parts.

All decisions as to the cause of failure are the sole determination of Wilden Pump and Engineering, LLC.

Prior approval must be obtained from Wilden for return of any items for warranty consideration and must be accompanied by the appropriate MSDS for the product(s) involved. A Return Goods Tag, obtained from an authorized Wilden distributor, must be included with the items which must be shipped freight prepaid.

The foregoing warranty is exclusive and in lieu of all other warranties expressed or implied (whether written or oral) including all implied warranties of merchantability and fitness for any particular purpose. No distributor or other person is authorized to assume any liability or obligation for Wilden Pump and Engineering, LLC other than expressly provided herein.

PLEASE PRINT OR TYPE AND FAX TO WILDEN

PUMP INFORMATION			
Item # _____		Serial # _____	
Company Where Purchased _____			
YOUR INFORMATION			
Company Name _____			
Industry _____			
Name _____		Title _____	
Street Address _____			
City _____	State _____	Postal Code _____	Country _____
Telephone _____	Fax _____	E-mail _____	Web Address _____
Number of pumps in facility? _____		Number of Wilden pumps? _____	
Types of pumps in facility (check all that apply): <input type="checkbox"/> Diaphragm <input type="checkbox"/> Centrifugal <input type="checkbox"/> Gear <input type="checkbox"/> Submersible <input type="checkbox"/> Lobe			
<input type="checkbox"/> Other _____			
Media being pumped? _____			
How did you hear of Wilden Pump? <input type="checkbox"/> Trade Journal <input type="checkbox"/> Trade Show <input type="checkbox"/> Internet/E-mail <input type="checkbox"/> Distributor			
<input type="checkbox"/> Other _____			

ONCE COMPLETE, FAX TO (909) 783-3440

NOTE: WARRANTY VOID IF PAGE IS NOT FAXED TO WILDEN
WILDEN PUMP & ENGINEERING, LLC

PSG® Brands

ABAQUE™
PERISTALTIC PUMPS
mouvex.com

ALMATEC®
AIR-OPERATED
DOUBLE-DIAPHRAGM PUMPS
almatec.de

AUTOMATIK
PELLETIZING SYSTEMS
maag.com

BLACKMER®
VANE PUMPS & COMPRESSORS
blackmer.com

FLUID DYNAMICS™
POLYMER BLENDING SYSTEMS
fluiddynamics1.com

GRISWOLD™
CENTRIFUGAL PUMPS
griswoldpump.com

**MAAG
FILTRATION**
PLASTIC MANUFACTURING &
PROCESSING FILTRATION
maag.com

**MAAG
INDUSTRIAL PUMPS**
GEAR & SCREW PUMPS
maag.com

**MAAG
PUMP SYSTEMS**
EXTRUSION PUMPS & SYSTEMS
maag.com

MOUVEX®
ECCENTRIC DISC PUMPS,
VANE PUMPS &
COMPRESSORS
mouvex.com

NEPTUNE™
DIAPHRAGM (METERING) PUMPS,
POLYMER SYSTEMS & MIXERS
neptune1.com

QUATTROFLOW™
QUATERNARY DIAPHRAGM
PUMP TECHNOLOGY
quattroflow.com

REDSCREW™
SCREW PUMPS
redscrewpump.com

SYSTEM ONE®
CENTRIFUGAL PUMPS
blackmer.com

WILDEN®
AIR-OPERATED
DOUBLE-DIAPHRAGM PUMPS
wildenpump.com



Where Innovation Flows

WILDEN®
Part of Pump Solutions Group
A DOVER COMPANY

22069 Van Buren St.
Grand Terrace, CA 92313-5651
T: +1 (909) 422-1731
F: +1 (909) 783-3440

PSG reserves the right to modify the information and illustrations contained in this document without prior notice. This is a non-contractual document. 01-2013

Authorized PSG Representative:

Copyright 2013, Pump Solutions Group (PSG), A Dover Company