

WILDEN®

Part of Pump Solutions Group

A **DOVER** COMPANY

EOM

Engineering
Operation &
Maintenance

PX15
Original™ Series
Metal Pump

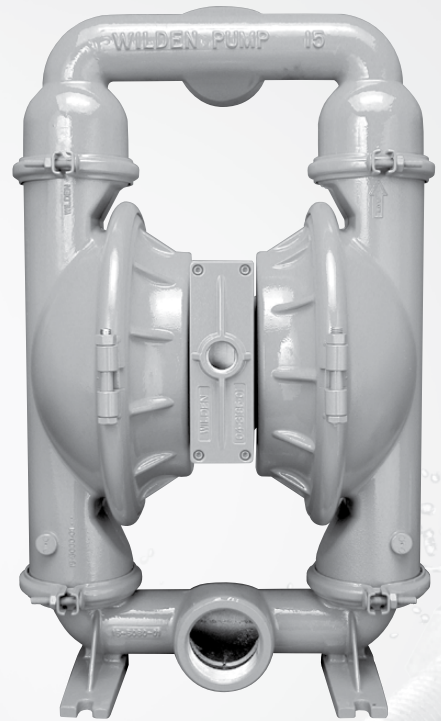

Where Innovation Flows

www.wildenpump.com

PROFLO® CE
PROGRESSIVE PUMP TECHNOLOGY

PROFLO™ X
PROGRESSIVE PUMP TECHNOLOGY

WIL-10330-E-06
REPLACES WIL-10330-E-05

TABLE OF CONTENTS

SECTION 1 CAUTIONS—READ FIRST! 1

SECTION 2 WILDEN PUMP DESIGNATION SYSTEM 2

SECTION 3 HOW IT WORKS—PUMP & AIR DISTRIBUTION SYSTEM 3

SECTION 4 DIMENSIONAL DRAWINGS 4

SECTION 5 PERFORMANCE

 A. PX15 Performance

 Operating Principle 6

 How to Use this EMS Curve 7

 Performance Curves

 Rubber-Fitted 10

 TPE-Fitted 11

 Reduced-Stroke PTFE-Fitted..... 12

 Full-Stroke PTFE-Fitted..... 13

 Ultra-Flex™ -Fitted 14

 B. Suction-Lift Curves..... 15

SECTION 6 SUGGESTED INSTALLATION, OPERATION & TROUBLESHOOTING..... 16

SECTION 7 ASSEMBLY / DISASSEMBLY 19

SECTION 8 EXPLODED VIEW & PARTS LISTING

 PX15 Metal

 Full-Stroke-Fitted 26

 Reduced-Stroke-Fitted 28

 Full-Stroke-Fitted (Plastic Center Block Assembly)..... 30

 Reduced-Stroke-Fitted (Plastic Center Block Assembly) 32

 Saniflo™ 1935/2004/EC 34

SECTION 9 ELASTOMER OPTIONS 37

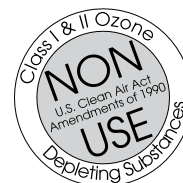

CAUTIONS—READ FIRST!

 **CAUTION:** Do not apply compressed air to the exhaust port — pump will not function.

 **CAUTION:** Do not over-lubricate air supply — excess lubrication will reduce pump performance. Pump is pre-lubed.

 **TEMPERATURE LIMITS:**

Polypropylene	0°C to 79°C	32°F to 175°F
PVDF	-12°C to 107°C	10°F to 225°F
PFA	7°C to 107°C	20°F to 225°F
Neoprene	-18°C to 93°C	0°F to 200°F
Buna-N	-12°C to 82°C	10°F to 180°F
EPDM	-51°C to 138°C	-60°F to 280°F
Viton® FKM	-40°C to 177°C	-40°F to 350°F
Wil-Flex™	-40°C to 107°C	-40°F to 225°F
Saniflex™	-29°C to 104°C	-20°F to 220°F
Polyurethane	-12°C to 66°C	10°F to 150°F
Polytetrafluoroethylene (PTFE) ¹	4°C to 104°C	40°F to 220°F
Nylon	-18°C to 93°C	0°F to 200°F
Acetal	-29°C to 82°C	-20°F to 180°F
SIPD PTFE with Neoprene-backed	4°C to 104°C	40°F to 220°F
SIPD PTFE with EPDM-backed	-10°C to 137°C	14°F to 280°F
Polyethylene	0°C to 70°C	32°F to 158°F
Geolast®	-40°C to 82°C	-40°F to 180°F

¹4°C to 149°C (40°F to 300°F) - 13 mm (1/2") and 25 mm (1") models only.

NOTE: Not all materials are available for all models. Refer to Section 2 for material options for your pump.

 **CAUTION:** When choosing pump materials, be sure to check the temperature limits for all wetted components. Example: Viton® has a maximum limit of 177°C (350°F) but polypropylene has a maximum limit of only 79°C (175°F).

 **CAUTION:** Maximum temperature limits are based upon mechanical stress only. Certain chemicals will significantly reduce maximum safe operating temperatures. Consult Chemical Resistance Guide (E4) for chemical compatibility and temperature limits.

 **WARNING:** Prevent static sparking. If static sparking occurs, fire or explosion could result. Pump, valves, and containers must be grounded to a proper grounding point when handling flammable fluids and whenever discharge of static electricity is a hazard.

 **CAUTION:** Do not exceed 8.6 bar (125 psig) air supply pressure.

 **CAUTION:** The process fluid and cleaning fluids must be chemically compatible with all wetted pump components. Consult Chemical Resistance Guide (E4).

 **CAUTION:** Do not exceed 82°C (180°F) air inlet temperature for Pro-Flo X™ models.

 **CAUTION:** Pumps should be thoroughly flushed before installing into process lines. FDA- and USDA-approved pumps should be cleaned and/or sanitized before being used.

 **CAUTION:** Always wear safety glasses when operating pump. If diaphragm rupture occurs, material being pumped may be forced out air exhaust.

 **CAUTION:** Before any maintenance or repair is attempted, the compressed air line to the pump should be disconnected and all air pressure allowed to bleed from pump. Disconnect all intake, discharge and air lines. Drain the pump by turning it upside down and allowing any fluid to flow into a suitable container.

 **CAUTION:** Blow out air line for 10 to 20 seconds before attaching to pump to make sure all pipeline debris is clear. Use an in-line air filter. A 5µ (micron) air filter is recommended.

 **NOTE:** When installing PTFE diaphragms, it is important to tighten outer pistons simultaneously (turning in opposite directions) to ensure tight fit. (See torque specifications in Section 7.)

 **NOTE:** Cast Iron PTFE-fitted pumps come standard from the factory with expanded PTFE gaskets installed in the diaphragm bead of the liquid chamber. PTFE gaskets cannot be re-used.

 **NOTE:** Before starting disassembly, mark a line from each liquid chamber to its corresponding air chamber. This line will assist in proper alignment during reassembly.

 **CAUTION:** Pro-Flo® pumps cannot be used in submersible applications. Pro-Flo X™ is available in both submersible and non-submersible options. Do not use non-submersible Pro-Flo X™ models in submersible applications. Turbo-Flo™ pumps can also be used in submersible applications.

 **CAUTION:** Tighten all hardware prior to installation.

WILDEN PUMP DESIGNATION SYSTEM

PX15 METAL

76 mm (3") Pump
Maximum Flow Rate:
918 lpm (243 gpm)

LEGEND

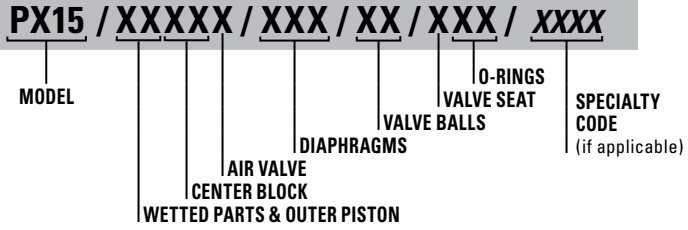

MATERIAL CODES

MODEL

PX15 = 76 mm (3")
XPX15 = 76 mm (3") ATEX

WETTED PARTS/OUTER PISTON¹

AA = ALUMINUM / ALUMINUM
SS = STAINLESS STEEL / STAINLESS STEEL
WW = DUCTILE IRON / DUCTILE IRON

AIR CHAMBERS

A = ALUMINUM
S = 316 STAINLESS STEEL

CENTER BLOCK

A = ALUMINUM
S = 316 STAINLESS STEEL
P = POLYPROPYLENE

AIR VALVE

A = ALUMINUM
S = 316 STAINLESS STEEL
P = POLYPROPYLENE

DIAPHRAGMS

BNS = BUNA-N (Red Dot)
XBS = CONDUCTIVE BUNA-N (Two Red Dots)²
EPS = EPDM (Blue Dot)²
PUS = POLYURETHANE (Clear)
NES = NEOPRENE (Green Dot)
TEU = PTFE w/EPDM BACK-UP (white)^{2,3,4,5}
TNU = PTFE w/NEOPRENE BACK-UP (White)
FSS = SANIFLEX™ [Hytrel® (Cream)]^{3,5}
VTS = VITON® (White Dot)
WFS = WIL-FLEX™ [Santoprene® (Orange Dot)]
TSU = PTFE W/SANIFLEX™ BACK-UP (White)^{3,4,5}
BNU = BUNA-N, ULTRA-FLEX™
EPU = EPDM, ULTRA-FLEX™²
NEU = NEOPRENE, ULTRA-FLEX™
VTU = VITON®, ULTRA-FLEX™
TSS = FULL-STROKE PTFE W/SANIFLEX™ BACK-UP^{3,4,5}
TWS = FULL-STROKE PTFE W/WIL-FLEX™ BACK-UP^{3,4,5}

VALVE BALL

BN = BUNA-N (Red Dot)
FS = SANIFLEX™ [Hytrel® (Cream)]
EP = EPDM (Blue Dot)^{2,3}
NE = NEOPRENE (Green Dot)
PU = POLYURETHANE (Brown)
TF = PTFE (White)^{3,4,5}
VT = VITON® (Silver or White Dot)
WF = WIL-FLEX™ [Santoprene® (Orange Dot)]

VALVE SEAT

A = ALUMINUM
BN = BUNA-N (Red Dot)
EP = EPDM (Blue Dot)²
FS = SANIFLEX™ [Hytrel® (Cream)]^{3,5}
NE = NEOPRENE (Green Dot)
PU = POLYURETHANE (Brown)
VT = VITON® (Silver or White Dot)
WF = WIL-FLEX™ [Santoprene® (Orange Dot)]
M = MILD STEEL
S = STAINLESS STEEL

VALVE SEAT O-RING

TF = PTFE (White)^{2,3,4,5}

NOTE:
¹ PTFE-fitted models require stainless steel outer piston.
² Meets the requirements of ATEX.
³ Meets Requirements of FDA CFR21.177
⁴ Meets Requirements of USP Class VI
⁵ Meets Requirements of 1935/2004/EC

SPECIALTY CODES

- | | | |
|--|---|---|
| 0014 BSPT | 0319 Single-Point Exhaust center block, BSPT | 0070E Saniflo™ FDA (1935/2004/EC) |
| 0022 External SS fasteners | 0320 Single-Point Exhaust center block | 0118E Stallion ball & seats only, BSPT0120 Saniflo™ FDA, Wil-Gard II™ 110V (1935/2004/EC) |
| 0044 Stallion balls & seats only | 0324 Single-Point Exhaust center block, Screen based | 0341E Single-Point Exhaust center block, Saniflo™ FDA (1935/2004/EC) |
| 0070 Saniflo™ FDA | 0327 Single-Point Exhaust center block, Stallion externals, balls & seats | |
| 0079 Tri-clamp™ fittings, wing nuts | 0341 Single-Point Exhaust center block, Saniflo™ FDA | |
| 0080 Tri-clamp™ fittings, ONLY | | |
| 0100 Wil-Gard II™ 110V | | |
| 0102 Wil-Gard II™ sensor wires ONLY | | |
| 0103 Wil-Gard II™ 220V | | |
| 0118 Stallion balls & seats only, BSPT0120 Saniflo™ FDA, Wil-Gard II™ 110V | | |

NOTE: MOST ELASTOMERIC MATERIALS USE COLORED DOTS FOR IDENTIFICATION.

NOTE: Not all models are available with all materials options.

Viton® is a registered trademark of DuPont Dow Elastomers.



HOW IT WORKS—PUMP

The Wilden diaphragm pump is an air-operated, positive displacement, self-priming pump. These drawings show flow pattern through the pump upon its initial stroke. It is assumed the pump has no fluid in it prior to its initial stroke.

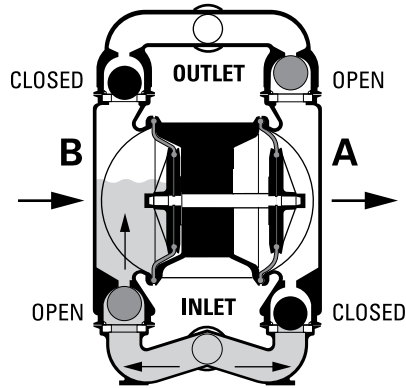

FIGURE 1 The air valve directs pressurized air to the back side of diaphragm A. The compressed air is applied directly to the liquid column separated by elastomeric diaphragms. The diaphragm acts as a separation membrane between the compressed air and liquid, balancing the load removes mechanical stress from the diaphragm. The compressed air moves the diaphragm away from the center of the pump. The opposite diaphragm is pulled in by the shaft connected to the pressurized diaphragm. Diaphragm B is on its suction stroke; air behind the diaphragm has been forced out to atmosphere through the exhaust port of the pump. The movement of diaphragm B toward the center of the pump creates a vacuum within chamber B. Atmospheric pressure forces fluid into the inlet manifold forcing the inlet valve ball off its seat. Liquid is free to move past the inlet valve ball and fill the liquid chamber (see shaded area).

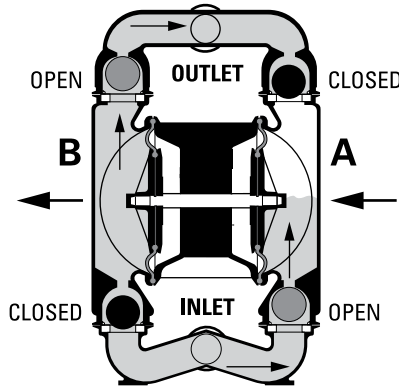

FIGURE 2 When the pressurized diaphragm, diaphragm A, reaches the limit of its discharge stroke, the air valve redirects pressurized air to the back side of diaphragm B. The pressurized air forces diaphragm B away from the center while pulling diaphragm A to the center. Diaphragm B is now on its discharge stroke. Diaphragm B forces the inlet valve ball onto its seat due to the hydraulic forces developed in the liquid chamber and manifold of the pump. These same hydraulic forces lift the discharge valve ball from its seat, forcing fluid to flow through the pump discharge. The movement of diaphragm A toward the center of the pump creates a vacuum within liquid chamber A. Atmospheric pressure forces fluid into the inlet manifold of the pump. The inlet valve ball is forced off its seat allowing the fluid being pumped to fill the liquid chamber.

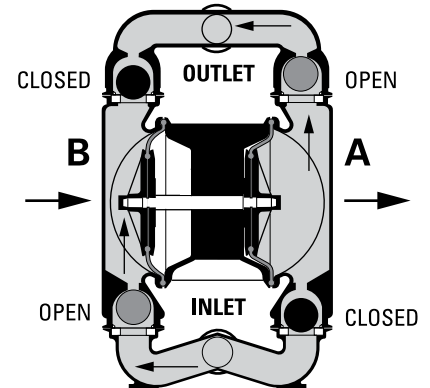
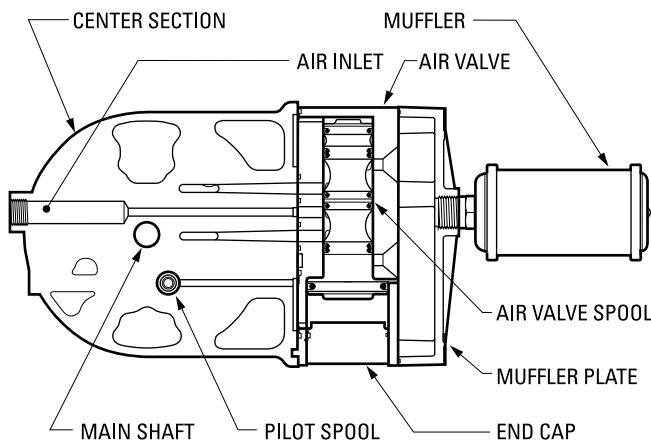

FIGURE 3 At completion of the stroke, the air valve again redirects air to the back side of diaphragm A, which starts diaphragm B on its exhaust stroke. As the pump reaches its original starting point, each diaphragm has gone through one exhaust and one discharge stroke. This constitutes one complete pumping cycle. The pump may take several cycles to completely prime depending on the conditions of the application.



HOW IT WORKS—AIR DISTRIBUTION SYSTEM



The Pro-Flo® patented air distribution system incorporates two moving parts: the air valve spool and the pilot spool. The heart of the system is the air valve spool and air valve. This valve design incorporates an unbalanced spool. The smaller end of the spool is pressurized continuously, while the large end is alternately pressurized then exhausted to move the spool. The spool directs pressurized air to one air chamber while exhausting the other. The air causes the main shaft/diaphragm assembly to shift to one side — discharging liquid on that side and pulling liquid in on the other side. When the shaft reaches the end of its stroke, the inner piston actuates the pilot spool, which pressurizes and exhausts the large end of the air valve spool. The repositioning of the air valve spool routes the air to the other air chamber.



DIMENSIONAL DRAWINGS

PX15 Metal

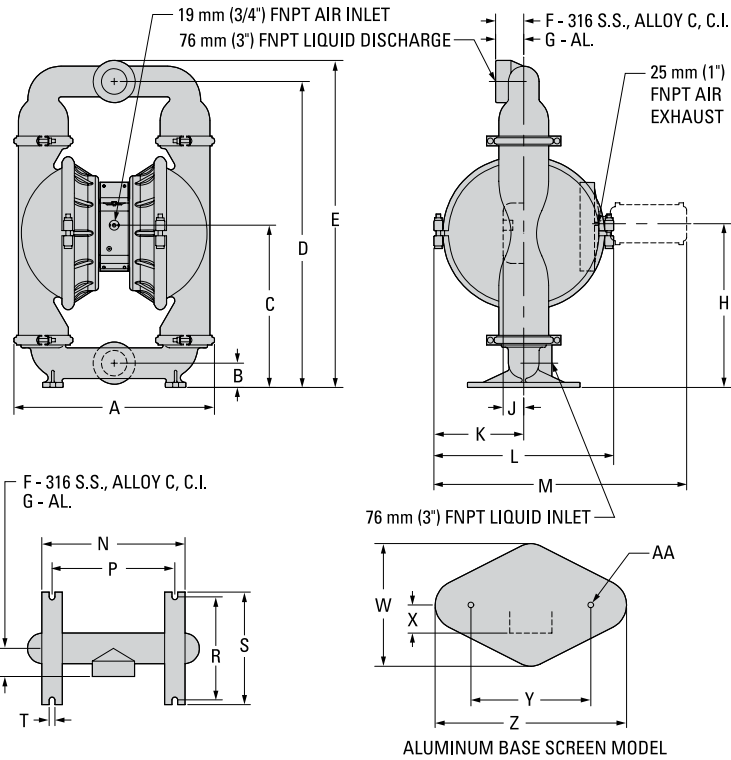

DIMENSIONS

ITEM	METRIC (mm)	STANDARD (inch)
A	505	19.9
B	58	2.3
C	386	15.2
D	762	30.0
E	823	32.4
F	71	2.8
G	84	3.3
H	389	15.3
J	48	1.9
K	216	8.5
L	427	16.8
M	599	23.6
N	363	14.3
P	307	12.1
R	257	10.1
S	282	11.1
T	18	0.7
U	71	2.8
V	69	2.7
W	307	12.1
X	84	3.3
Y	305	12.0
Z	478	18.8
AA	15 DIA.	.6 DIA.

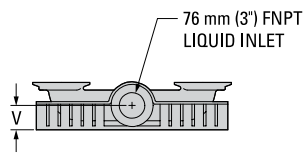
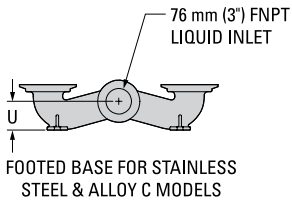

PX15 Metal Saniflo^{FDA}

DIMENSIONS

ITEM	METRIC (mm)	STANDARD (inch)
A	521	20.5
B	71	2.8
C	396	15.6
D	767	30.2
E	810	31.9
F	89	3.5
G	406	16.0
H	48	1.9
J	216	8.5
K	424	16.7
L	599	23.6
M	356	14.0
N	305	12.0
P	257	10.1
R	279	11.0
S	15 DIA.	.6 DIA.

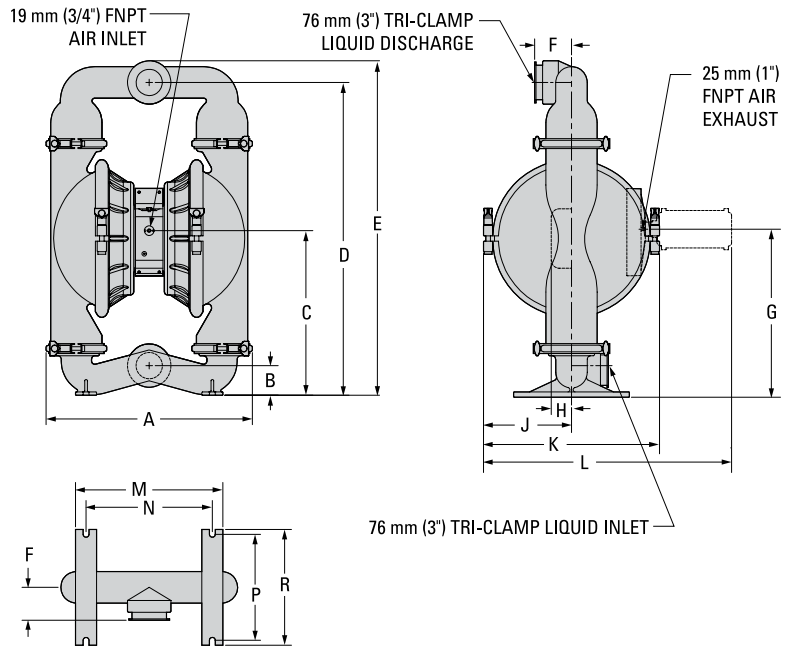

PX15

M E T A L

WILDEN
A DOVER COMPANY

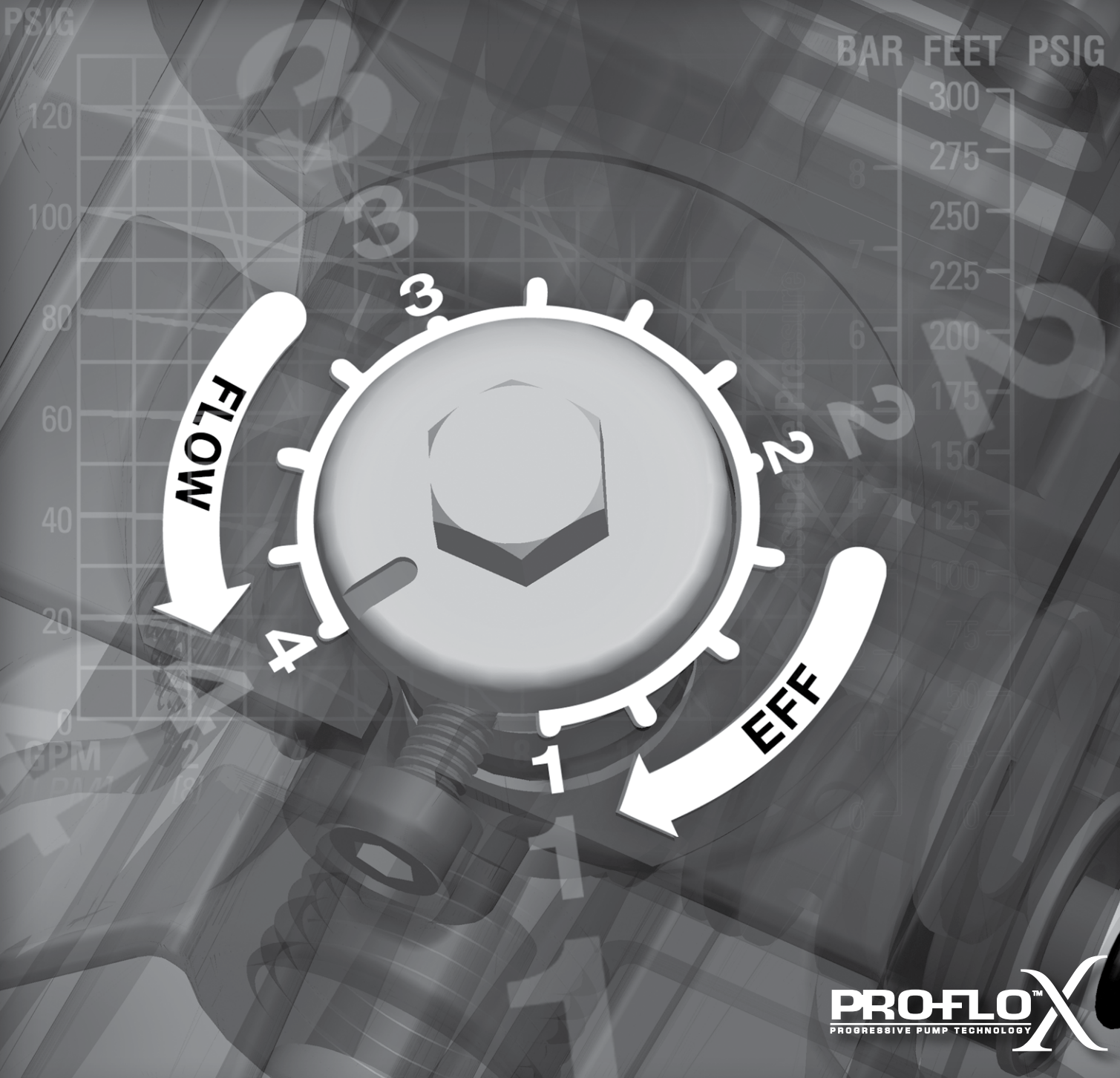

PROFLOTM
PROGRESSIVE PUMP TECHNOLOGY

PX15 PERFORMANCE



Pro-Flo X™ Operating Principle

The Pro-Flo X™ air distribution system with the revolutionary Efficiency Management System (EMS) offers flexibility never before seen in the world of AODD pumps. The EMS is simple and easy to use. With the turn of an integrated control dial, the

operator can select the optimal balance of flow and efficiency that best meets the application needs. Pro-Flo X™ provides higher performance, lower operational costs and flexibility that exceeds previous industry standards.



<p>Turning the dial changes the relationship between air inlet and exhaust porting.</p>	<p>Each dial setting represents an entirely different flow curve.</p>	<p>Pro-Flo X™ pumps are shipped from the factory on setting 4, which is the highest flow rate setting possible.</p>	<p>Moving the dial from setting 4 causes a decrease in flow and an even greater decrease in air consumption.</p>	<p>When the air consumption decreases more than the flow rate, efficiency is improved and operating costs are reduced.</p>

Example 1

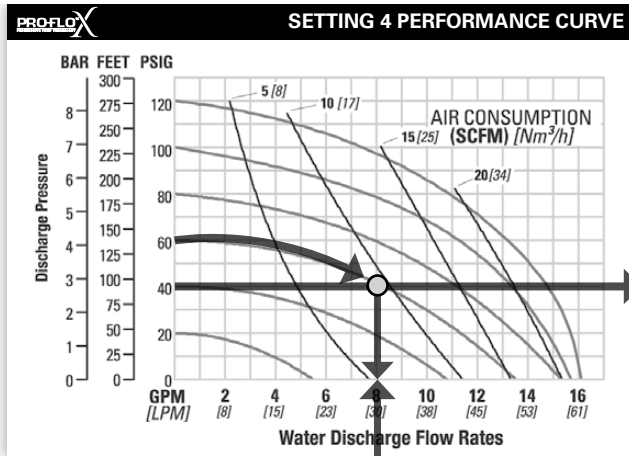

Figure 1

Example data point = **8.2** GPM

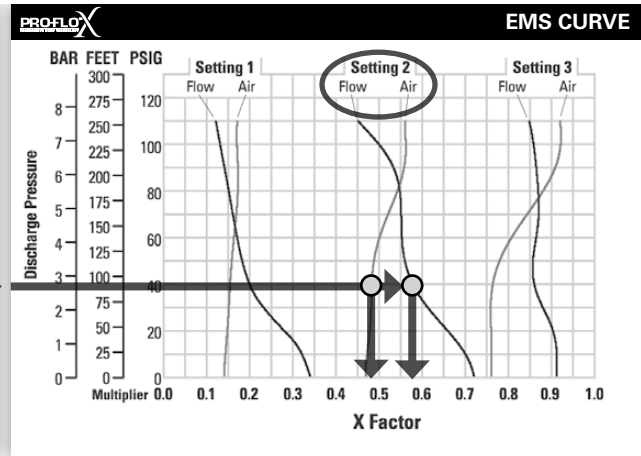

Figure 2

Example data point = **0.58** flow multiplier
0.48 air multiplier

This is an example showing how to determine flow rate and air consumption for your Pro-Flo X™ pump using the Efficiency Management System (EMS) curve and the performance curve. For this example we will be using 4.1 bar (60 psig) inlet air pressure and 2.8 bar (40 psig) discharge pressure and EMS setting 2.

Step 1: Identifying performance at setting 4. Locate the curve that represents the flow rate of the pump with 4.1 bar (60 psig) air inlet pressure. Mark the point where this curve crosses the horizontal line representing 2.8 bar (40 psig) discharge pressure. (Figure 1). After locating your performance point on the flow curve, draw a vertical line downward until reaching the bottom scale on the chart. Identify the flow rate (in this case, 8.2 gpm). Observe location of performance point relative to air consumption curves and approximate air consumption value (in this case, 9.8 scfm).

Step 2: Determining flow and air X Factors. Locate your discharge pressure (40 psig) on the vertical axis of the EMS curve (Figure 2). Follow along the 2.8 bar (40 psig) horizontal line until intersecting both flow and air curves for your desired EMS setting (in this case, setting 2). Mark the points where the EMS curves intersect the horizontal discharge pressure line. After locating your EMS points on the EMS

curve, draw vertical lines downward until reaching the bottom scale on the chart. This identifies the flow X Factor (in this case, 0.58) and air X Factor (in this case, 0.48).

Step 3: Calculating performance for specific EMS setting. Multiply the flow rate (8.2 gpm) obtained in Step 1 by the flow X Factor multiplier (0.58) in Step 2 to determine the flow rate at EMS setting 2. Multiply the air consumption (9.8 scfm) obtained in Step 1 by the air X Factor multiplier (0.48) in Step 2 to determine the air consumption at EMS setting 2 (Figure 3).

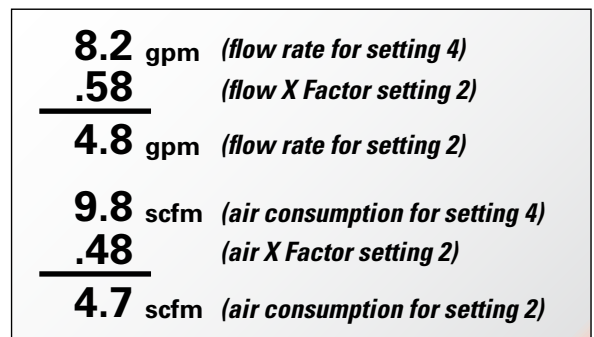

Figure 3

The flow rate and air consumption at Setting 2 are found to be 18.2 lpm (4.8 gpm) and 7.9 Nm³/h (4.7 scfm) respectively.

Example 2.1

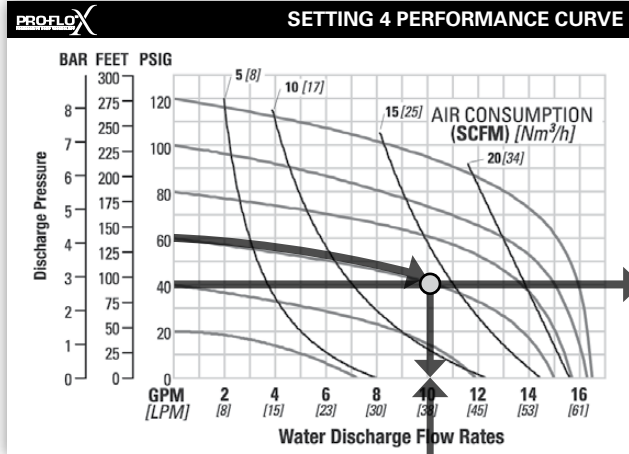

Figure 4

Example data point = **10.2** gpm

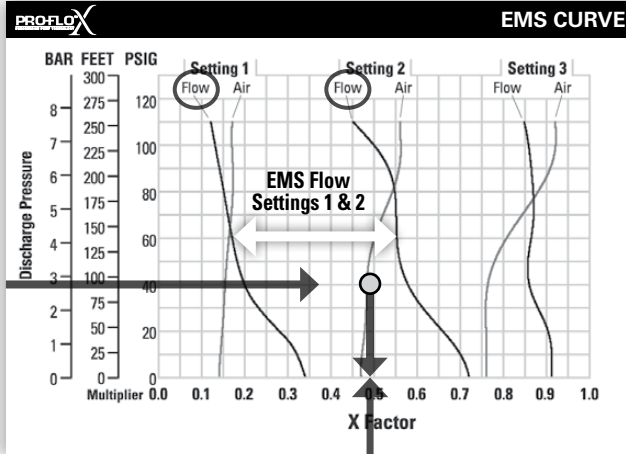

Figure 5

0.49 flow multiplier

This is an example showing how to determine the inlet air pressure and the EMS setting for your Pro-Flo X™ pump to optimize the pump for a specific application. For this example we will be using an application requirement of 18.9 lpm (5 gpm) flow rate against 2.8 bar (40 psig) discharge pressure. This example will illustrate how to calculate the air consumption that could be expected at this operational point.

DETERMINE EMS SETTING

Step 1: Establish inlet air pressure. Higher air pressures will typically allow the pump to run more efficiently, however, available plant air pressure can vary greatly. If an operating pressure of 6.9 bar (100 psig) is chosen when plant air frequently dips to 6.2.1 bar (90 psig) pump performance will vary. Choose an operating pressure that is within your compressed air system's capabilities. For this example we will choose 4.1 bar (60 psig).

Step 2: Determine performance point at setting 4. For this example an inlet air pressure of 4.1 bar (60 psig) inlet air pressure has been chosen. Locate the curve that represents the performance of the pump with 4.1 bar (60 psig) inlet air pressure. Mark the point where this curve crosses the horizontal line representing 2.8 bar (40 psig) discharge pressure. After locating this point on the flow curve, draw a vertical line downward until reaching the bottom scale on the chart and identify the flow rate.

In our example it is 38.6 lpm (10.2 gpm). This is the setting 4 flow rate. Observe the location of the performance point relative to air consumption curves and approximate air consumption value. In our example setting 4 air consumption is 24 Nm³/h (14 scfm). (See Figure 4.)

Step 3: Determine flow X Factor. Divide the required flow rate 18.9 lpm (5 gpm) by the setting 4 flow rate 38.6 lpm (10.2 gpm) to determine the flow X Factor for the application.

$$5 \text{ gpm} / 10.2 \text{ gpm} = 0.49 \text{ (flow X Factor)}$$

Step 4: Determine EMS setting from the flow X Factor. Plot the point representing the flow X Factor (0.49) and the application discharge pressure 2.8 bar (40 psig) on the EMS curve. This is done by following the horizontal 2.8 bar (40 psig) psig discharge pressure line until it crosses the vertical 0.49 X Factor line. Typically, this point lies between two flow EMS setting curves (in this case, the point lies between the flow curves for EMS setting 1 and 2). Observe the location of the point relative to the two curves it lies between and approximate the EMS setting (Figure 5). For more precise results you can mathematically interpolate between the two curves to determine the optimal EMS setting.

For this example the EMS setting is 1.8.

Example 2.2

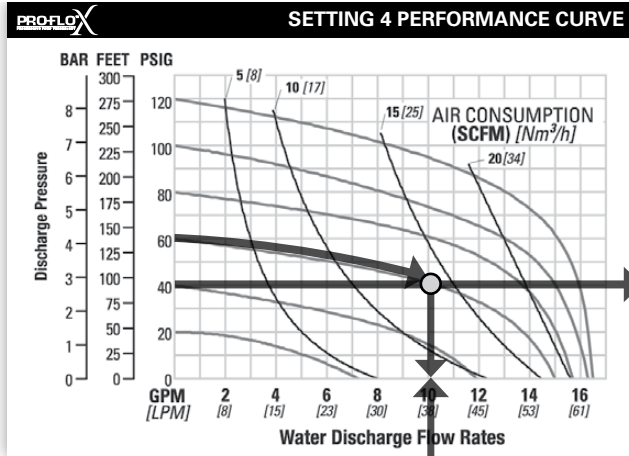

Figure 6

Example data point = **10.2** gpm

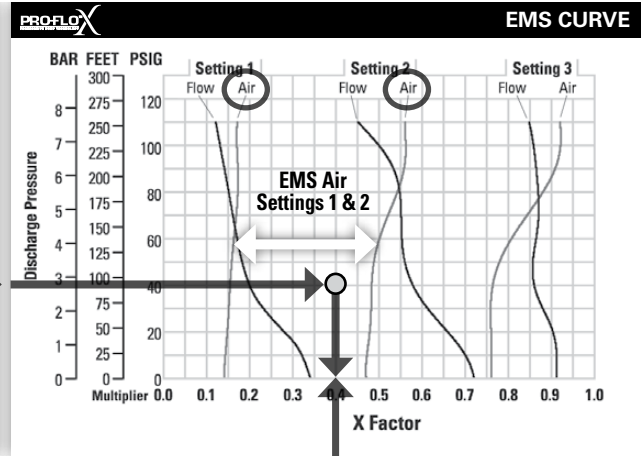

Figure 7

Example data point = **0.40** air multiplier

Determine air consumption at a specific EMS setting.

Step 1: Determine air X Factor. In order to determine the air X Factor, identify the two air EMS setting curves closest to the EMS setting established in example 2.1 (in this case, the point lies between the air curves for EMS setting 1 and 2). The point representing your EMS setting (1.8) must be approximated and plotted on the EMS curve along the horizontal line representing your discharge pressure (in this case, 40 psig). This air point is different than the flow point plotted in example 2.1. After estimating (or interpolating) this point on the curve, draw a vertical line downward until reaching the bottom scale on the chart and identify the air X Factor (Figure 7).

For this example the air X Factor is **0.40**.

Step 2: Determine air consumption. Multiply your setting 4 air consumption (14 scfm) value by the air X Factor obtained above (0.40) to determine your actual air consumption.

$$14 \text{ scfm} \times 0.40 = 5.6 \text{ SCFM}$$

In summary, for an application requiring 18.9 lpm (5 gpm) against 2.8 bar (40 psig) discharge pressure, the pump inlet air pressure should be set to 4.1 bar (60 psig) and the EMS dial should be set to 1.8. The pump would then consume 9.5 Nm³/h (5.6 scfm) of compressed air.

PX15 METAL RUBBER-FITTED



PERFORMANCE



SETTING 4 PERFORMANCE CURVE

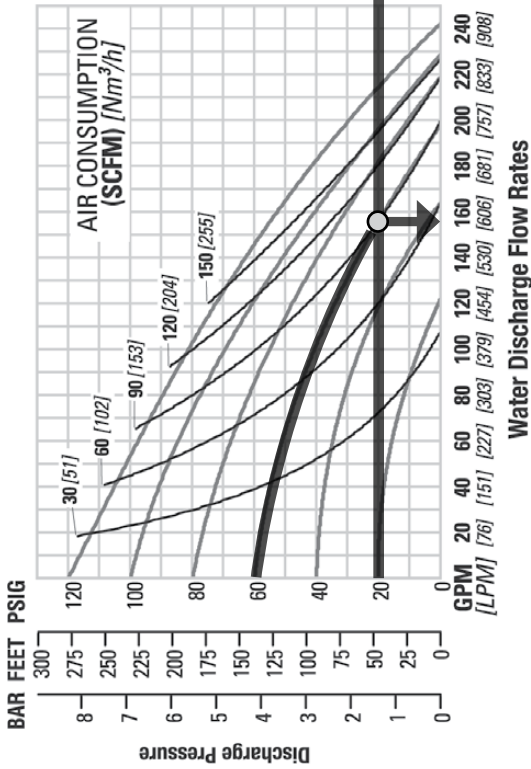

EMS CURVE

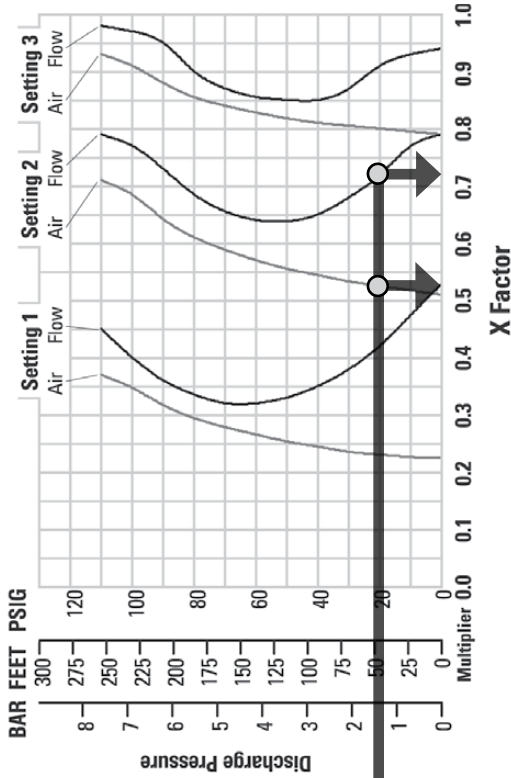

TECHNICAL DATA

Height823 mm (32.4")
Width505 mm (19.9")
Depth406 mm (16.0")
Ship WeightAluminum 60 kg (132 lb)
316 Stainless Steel 90 kg (198 lb)
Air Inlet Cast Iron 98 kg (216 lb)
Inlet 19 mm (3/4")
Outlet 76 mm (3")
Suction Lift 6.7 m Dry (22.1')
 9.5 m Wet (31.2')
Disp. per Stroke 5.03 L (1.33 gal) ¹
Max. Flow Rate 918 lpm (243 gpm)
Max. Size Solids 9.5 mm (3/8")

¹Displacement per stroke was calculated at 4.8 bar (70 psig) air inlet pressure against a 2.1 bar (30 psig) head pressure.

The Efficiency Management System (EMS) can be used to optimize the performance of your Wilden pump for specific applications. The pump is delivered with the EMS adjusted to setting 4, which allows maximum flow.

The Efficiency Management System (EMS) can be used to optimize the performance of your Wilden pump for specific applications. The pump is delivered with the EMS adjusted to setting 4, which allows maximum flow.

The EMS curve allows the pump user to determine flow and air consumption at each EMS setting. For any EMS setting and discharge pressure, the X factor is used as a multiplier with the original values from the setting 4 performance curve to calculate the actual flow and air consumption values for that specific EMS setting. NOTE: You can interpolate between the setting curves for operation at intermediate EMS settings.

EXAMPLE

A PX15 aluminum, rubber-fitted pump operating at EMS setting 4, achieved a flow rate of 591 lpm (156 gpm) using 153 Nm³/h (90 scfm) of air when run at 4.1 bar (60 psig) air inlet pressure and 1.4 bar (20 psig) discharge pressure (see dot on performance curve).

The end user did not require that much flow and wanted to reduce air consumption at his facility. He determined that EMS setting 2 would meet his needs. At 1.4 bar (20 psig) discharge pressure and EMS setting 2, the flow X factor is 0.72 and the air X factor is 0.53 (see dots on EMS curve).

Multiplying the original setting 4 values by the X factors provides the setting 2 flow rate of 425 lpm (112 gpm) and an air consumption of 72 Nm³/h (42 scfm). The flow rate was reduced by 28% while the air consumption was reduced by 53%, thus providing increased efficiency.

For a detailed example for how to set your EMS, see beginning of performance curve section.

CAUTION: Do not exceed 8.6 bar (125 psig) air supply pressure.

PX15 METAL TPE-FITTED

SETTING 4 PERFORMANCE CURVE

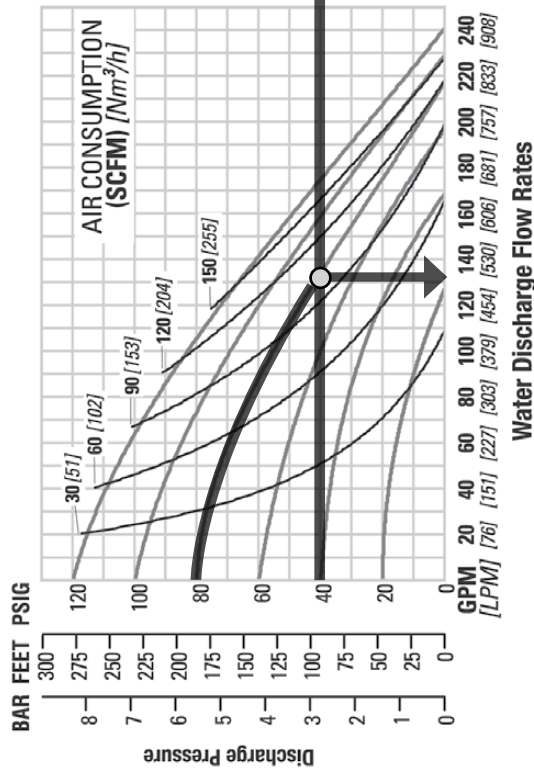

EMS CURVE

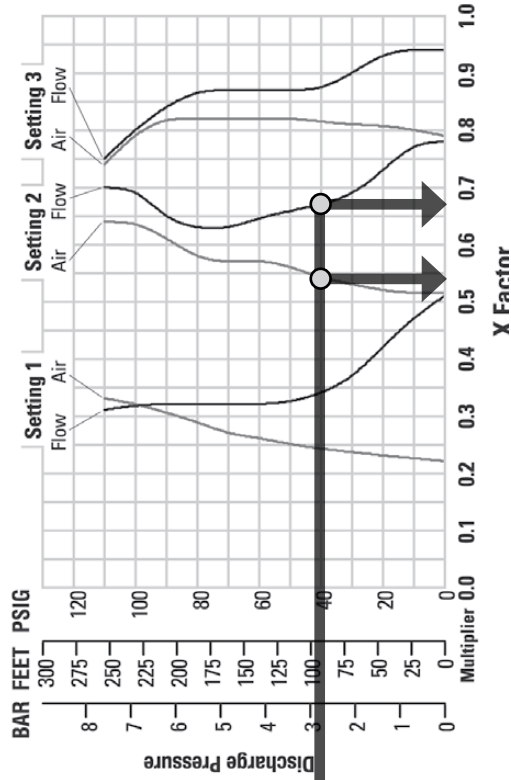

PERFORMANCE



TECHNICAL DATA

Height823 mm (32.4")
Width505 mm (19.9")
Depth406 mm (16.0")
Ship WeightAluminum 60 kg (132 lb)316 Stainless Steel 90 kg (198 lb)
Air Inlet19 mm (3/4")
Inlet76 mm (3")
Outlet76 mm (3")
Suction Lift6.2 m Dry (20.4')9.3 m Wet (30.6')
Disp. per Stroke4.47 L (1.18 gal) ¹
Max. Flow Rate913 lpm (241 gpm)
Max. Size Solids9.5 mm (3/8")

¹Displacement per stroke was calculated at 4.8 bar (70 psig) air inlet pressure against a 2.1 bar (30 psig) head pressure.

The Efficiency Management System (EMS) can be used to optimize the performance of your Wilden pump for specific applications. The pump is delivered with the EMS adjusted to setting 4, which allows maximum flow.

The Efficiency Management System (EMS) can be used to optimize the performance of your Wilden pump for specific applications. The pump is delivered with the EMS adjusted to setting 4, which allows maximum flow.

The EMS curve allows the pump user to determine flow and air consumption at each EMS setting. For any EMS setting and discharge pressure, the X factor is used as a multiplier with the original values from the setting 4 performance curve to calculate the actual flow and air consumption values for that specific EMS setting. NOTE: You can interpolate between the setting curves for operation at intermediate EMS settings.

EXAMPLE

A PX15 aluminum, TPE-fitted pump operating at EMS setting 4, achieved a flow rate of 503 lpm (133 gpm) using 175 Nm³/h (103 scfm) of air when run at 5.5 bar (80 psig) air inlet pressure and 2.8 bar (40 psig) discharge pressure (see dot on performance curve).

The end user did not require that much flow and wanted to reduce air consumption at his facility. He determined that EMS setting 2 would meet his needs. At 2.8 bar (40 psig) discharge pressure and EMS setting 2, the flow X factor is 0.67 and the air X factor is 0.54 (see dots on EMS curve).

Multiplying the original setting 4 values by the X factors provides the setting 2 flow rate of 337 lpm (89 gpm) and an air consumption of 94 Nm³/h (56 scfm). The flow rate was reduced by 33% while the air consumption was reduced by 46%, thus providing increased efficiency.

For a detailed example for how to set your EMS, see beginning of performance curve section.

CAUTION: Do not exceed 8.6 bar (125 psig) air supply pressure.

PX15 METAL REDUCED-STROKE PTFE-FITTED



PERFORMANCE



SETTING 4 PERFORMANCE CURVE

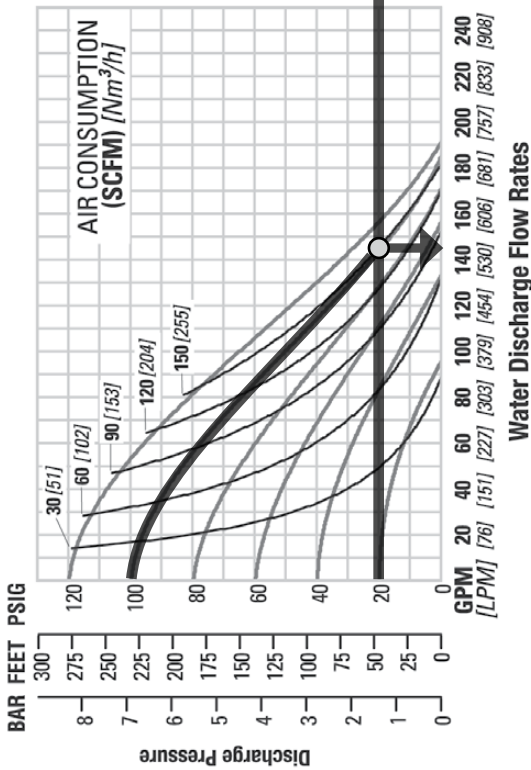

EMS CURVE

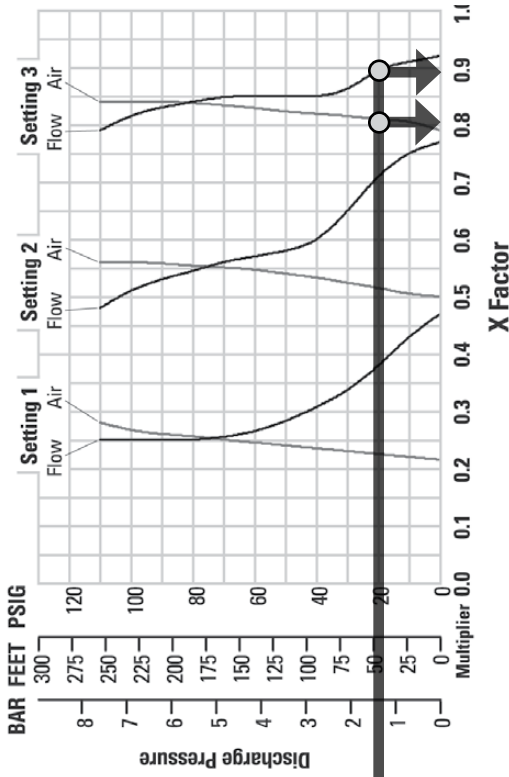

TECHNICAL DATA

Height823 mm (32.4")
Width505 mm (19.9")
Depth406 mm (16.0")
Ship WeightAluminum 60 kg (132 lb)
316 Stainless Steel 90 kg (198 lb)
Air InletCast Iron 98 kg (216 lb)
Inlet19 mm (3/4")
Outlet76 mm (3")
Suction Lift76 mm (3")
4.8 m Dry (15.9')
9.5 m Wet (31.2')
Disp. per Stroke3.14 L (0.83 gal)
Max. Flow Rate727 lpm (192 gpm)
Max. Size Solids9.5 mm (3/8")

*Displacement per stroke was calculated at 4.8 bar (70 psig) air inlet pressure against a 2.1 bar (30 psig) head pressure.

The Efficiency Management System (EMS) can be used to optimize the performance of your Wilden pump for specific applications. The pump is delivered with the EMS adjusted to setting 4, which allows maximum flow.

The Efficiency Management System (EMS) can be used to optimize the performance of your Wilden pump for specific applications. The pump is delivered with the EMS adjusted to setting 4, which allows maximum flow.

The EMS curve allows the pump user to determine flow and air consumption at each EMS setting. For any EMS setting and discharge pressure, the X factor is used as a multiplier with the original values from the setting 4 performance curve to calculate the actual flow and air consumption values for that specific EMS setting. NOTE: You can interpolate between the setting curves for operation at intermediate EMS settings.

EXAMPLE

A PX15 aluminum, reduced-stroke PTFE-fitted pump operating at EMS setting 4, achieved a flow rate of 545 lpm (144 gpm) using 253 Nm³/h (149 scfm) of air when run at 6.9 bar (100 psig) air inlet pressure and 1.4 bar (20 psig) discharge pressure (see dot on performance curve).

The end user did not require that much flow and wanted to reduce air consumption at his facility. He determined that EMS setting 3 would meet his needs. At 1.4 bar (20 psig) discharge pressure and EMS setting 3, the flow X factor is 0.89 and the air X factor is 0.81 (see dots on EMS curve).

Multiplying the original setting 4 values by the X factors provides the setting 3 flow rate of 485 lpm (128 gpm) and an air consumption of 205 Nm³/h (121 scfm). The flow rate was reduced by 11% while the air consumption was reduced by 19%, thus providing increased efficiency.

For a detailed example for how to set your EMS, see beginning of performance curve section.

CAUTION: Do not exceed 8.6 bar (125 psig) air supply pressure.

PX15 METAL FULL-STROKE PTFE-FITTED

SETTING 4 PERFORMANCE CURVE

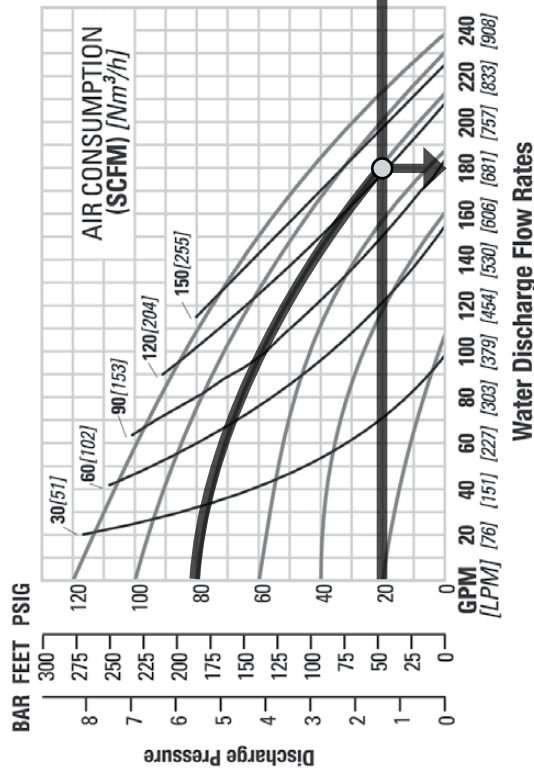

EMS CURVE

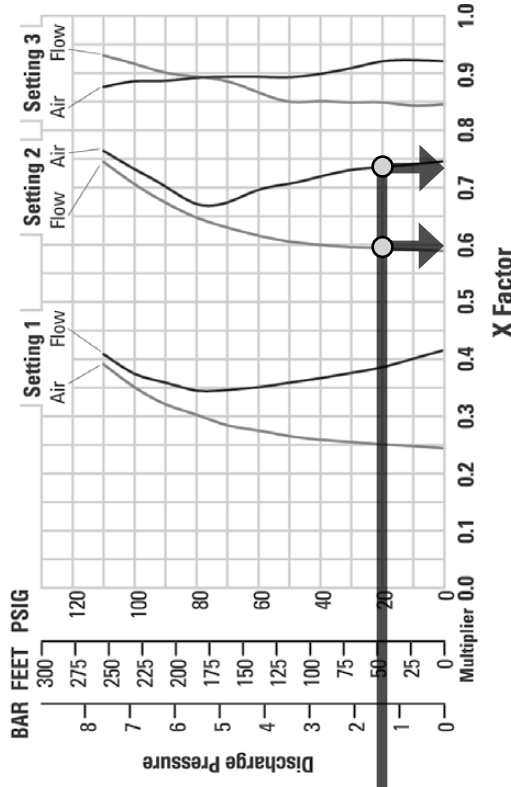

TECHNICAL DATA

Height823 mm (32.4")
Width505 mm (19.9")
Depth406 mm (16.0")
Ship WeightAluminum 60 kg (132 lb)
316 Stainless Steel 90 kg (198 lb)
Air InletCast Iron 98 kg (216 lb)
Inlet19 mm (3/4")
Outlet76 mm (3")
Suction Lift76 mm (3")
6.6 m Dry (21.6')
9.0 m Wet (29.5')
Disp. per Stroke5.1 L (1.34 gal)
Max. Flow Rate902 lpm (238 gpm)
Max. Size Solids9.5 mm (3/8")

*Displacement per stroke was calculated at 4.8 bar (70 psig) air inlet pressure against a 2.1 bar (30 psig) head pressure.

The Efficiency Management System (EMS) can be used to optimize the performance of your Wilden pump for specific applications. The pump is delivered with the EMS adjusted to setting 4, which allows maximum flow.

The Efficiency Management System (EMS) can be used to optimize the performance of your Wilden pump for specific applications. The pump is delivered with the EMS adjusted to setting 4, which allows maximum flow.

The EMS curve allows the pump user to determine flow and air consumption at each EMS setting. For any EMS setting and discharge pressure, the X factor is used as a multiplier with the original values from the setting 4 performance curve to calculate the actual flow and air consumption values for that specific EMS setting. NOTE: You can interpolate between the setting curves for operation at intermediate EMS settings.

EXAMPLE

A PX15 aluminum, full-stroke PTFE-fitted pump operating at EMS setting 4, achieved a flow rate of 681 lpm (180 gpm) using 209 Nm³/h (123 scfm) of air when run at 5.5 bar (80 psig) air inlet pressure and 1.4 bar (20 psig) discharge pressure (see dot on performance curve).

The end user did not require that much flow and wanted to reduce air consumption at his facility. He determined that EMS setting 2 would meet his needs. At 1.4 bar (20 psig) discharge pressure and EMS setting 2, the flow X factor is 0.73 and the air X factor is 0.59 (see dots on EMS curve).

Multiplying the original setting 4 values by the X factors provides the setting 2 flow rate of 497 lpm (131 gpm) and an air consumption of 123 Nm³/h (73 scfm). The flow rate was reduced by 27% while the air consumption was reduced by 41%, thus providing increased efficiency.

For a detailed example for how to set your EMS, see beginning of performance curve section.

CAUTION: Do not exceed 8.6 bar (125 psig) air supply pressure.

PX15 METAL ULTRA-FLEX™ FITTED

SETTING 4 PERFORMANCE CURVE

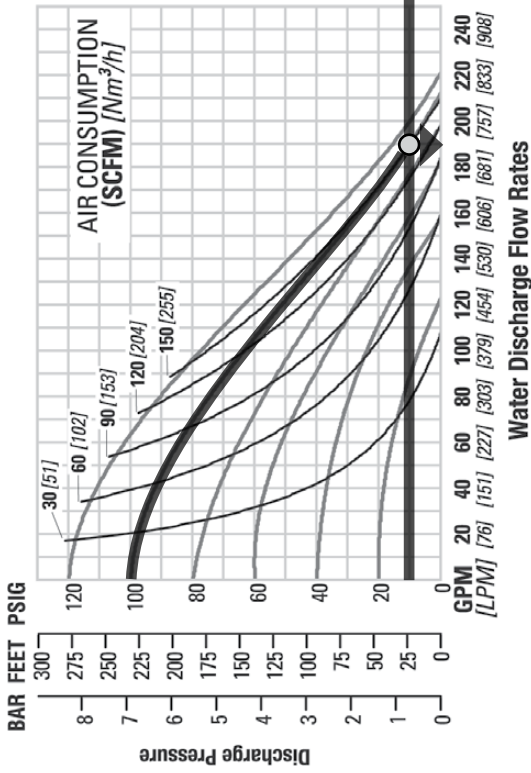

EMS CURVE

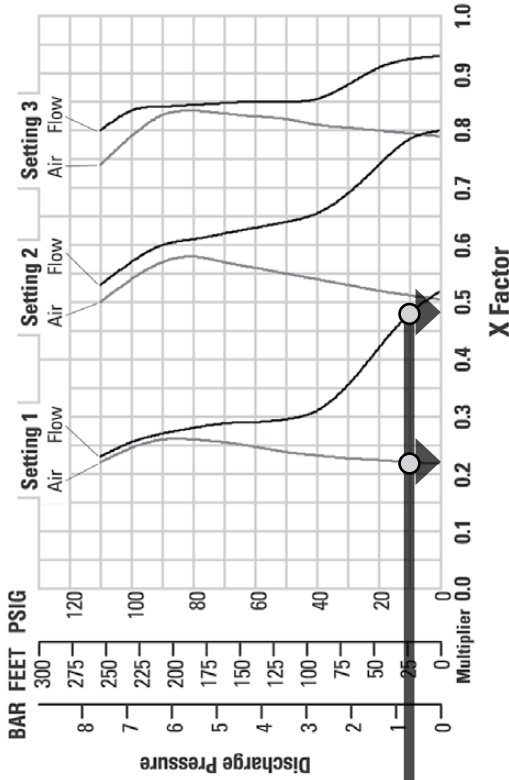

PERFORMANCE



TECHNICAL DATA

Height823 mm (32.4")
Width505 mm (19.9")
Depth406 mm (16.0")
Ship WeightAluminum 60 kg (132 lb)
316 Stainless Steel 90 kg (198 lb)
Air Inlet19 mm (3/4")
Inlet76 mm (3")
Outlet76 mm (3")
Suction Lift6.2 m Dry (20.4')
9.5 m Wet (31.2')
Disp. per Stroke4.43 L (1.17 gal) ¹
Max. Flow Rate840 lpm (222 gpm)
Max. Size Solids9.5 mm (3/8")

¹Displacement per stroke was calculated at 4.8 bar (70 psig) air inlet pressure against a 2.1 bar (30 psig) head pressure.

The Efficiency Management System (EMS) can be used to optimize the performance of your Wilden pump for specific applications. The pump is delivered with the EMS adjusted to setting 4, which allows maximum flow.

EXAMPLE

A PX15 aluminum, Ultra-Flex-fitted pump operating at EMS setting 4, achieved a flow rate of 719 lpm (190 gpm) using 255 Nm³/h (150 scfm) of air when run at 6.9 bar (100 psig) air inlet pressure and 0.7 bar (10 psig) discharge pressure (see dot on performance curve).

The end user did not require that much flow and wanted to reduce air consumption at his facility. He determined that EMS setting 1 would meet his needs. At 0.7 bar (10 psig) discharge pressure and EMS setting 1, the flow X factor is 0.48 and the air X factor is 0.22 (see dots on EMS curve).

Multiplying the original setting 4 values by the X factors provides the setting 1 flow rate of 345 lpm (91 gpm) and an air consumption of 56 Nm³/h (33 scfm). The flow rate was reduced by 52% while the air consumption was reduced by 78%, thus providing increased efficiency.

For a detailed example for how to set your EMS, see beginning of performance curve section.

CAUTION: Do not exceed 8.6 bar (125 psig) air supply pressure.



SUCTION-LIFT CURVES

PX15 METAL SUCTION-LIFT CAPABILITY

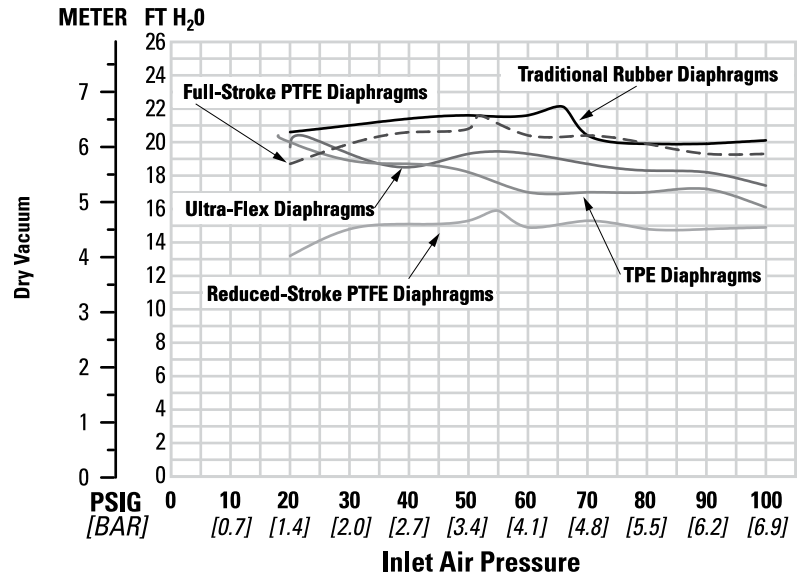

Suction-lift curves are calibrated for pumps operating at 305 m (1,000') above sea level. This chart is meant to be a guide only. There are many variables that can affect your pump's operating characteristics. The

number of intake and discharge elbows, viscosity of pumping fluid, elevation (atmospheric pressure) and pipe friction loss all affect the amount of suction lift your pump will attain.

SUGGESTED INSTALLATION

Wilden pumps are designed to meet the performance requirements of even the most demanding pumping applications. They have been designed and manufactured to the highest standards and are available in a variety of liquid path materials to meet your chemical resistance needs. Refer to the performance section of this manual for an in-depth analysis of the performance characteristics of your pump. Wilden offers the widest variety of elastomer options in the industry to satisfy temperature, chemical compatibility, abrasion resistance and flex concerns.

The suction pipe size should be at least the equivalent or larger than the diameter size of the suction inlet on your Wilden pump. The suction hose must be non-collapsible, reinforced type as these pumps are capable of pulling a high vacuum. Discharge piping should also be the equivalent or larger than the diameter of the pump discharge which will help reduce friction losses. It is critical that all fittings and connections are airtight or a reduction or loss of pump suction capability will result.

INSTALLATION: Months of careful planning, study, and selection efforts can result in unsatisfactory pump performance if installation details are left to chance.

Premature failure and long-term dissatisfaction can be avoided if reasonable care is exercised throughout the installation process.

LOCATION: Noise, safety and other logistical factors usually dictate where equipment will be situated on the production floor. Multiple installations with conflicting requirements can result in congestion of utility areas, leaving few choices for additional pumps.

Within the framework of these and other existing conditions, every pump should be located in such a way that six key factors are balanced against each other to maximum advantage.

ACCESS: First of all, the location should be accessible. If it's easy to reach the pump, maintenance personnel will have an easier time carrying out routine inspections and adjustments. Should major repairs become necessary, ease of access can play a key role in speeding the repair process and reducing total downtime.

AIR SUPPLY: Every pump location should have an air line large enough to supply the volume of air necessary to achieve the desired pumping rate. Use air pressure up to a maximum of 8.6 bar (125 psig) depending on pumping requirements.

For best results, the pumps should use a 5 μ (micron) air filter, needle valve and regulator. The use of an air filter before the pump will ensure that the majority of any pipeline contaminants will be eliminated.

SOLENOID OPERATION: When operation is controlled by a solenoid valve in the air line, three-way valves should be used. This valve allows trapped air between the valve and the pump to bleed off which improves pump performance. Pumping volume can be estimated by counting the number of strokes per minute and then multiplying the figure by the displacement per stroke.

MUFFLER: Sound levels are reduced below OSHA specifications using the standard Wilden muffler. Other mufflers can be used to further reduce sound levels, but they usually reduce pump performance.

ELEVATION: Selecting a site that is well within the pump's dynamic lift capability will assure that loss-of-prime issues will be eliminated. In addition, pump efficiency can be adversely affected if proper attention is not given to site location.

PIPING: Final determination of the pump site should not be made until the piping challenges of each possible location have been evaluated. The impact of current and future installations should be considered ahead of time to make sure that inadvertent restrictions are not created for any remaining sites.

The best choice possible will be a site involving the shortest and straightest hook-up of suction and discharge piping. Unnecessary elbows, bends, and fittings should be avoided. Pipe sizes should be selected to keep friction losses within practical limits. All piping should be supported independently of the pump. In addition, the piping should be aligned to avoid placing stress on the pump fittings.

Flexible hose can be installed to aid in absorbing the forces created by the natural reciprocating action of the pump. If the pump is to be bolted down to a solid location, a mounting pad placed between the pump and the foundation will assist in minimizing pump vibration. Flexible connections between the pump and rigid piping will also assist in minimizing pump vibration. If quick-closing valves are installed at any point in the discharge system, or if pulsation within a system becomes a problem, a surge suppressor (SD Equalizer[®]) should be installed to protect the pump, piping and gauges from surges and water hammer.

If the pump is to be used in a self-priming application, make sure that all connections are airtight and that the suction lift is within the model's ability. **NOTE:** Materials of construction and elastomer material have an effect on suction lift parameters. Please refer to the performance section for specifics.

When pumps are installed in applications involving flooded suction or suction head pressures, a gate valve should be installed in the suction line to permit closing of the line for pump service.

Pumps in service with a positive suction head are most efficient when inlet pressure is limited to 0.5–0.7 bar (7–10 psig). Premature diaphragm failure may occur if positive suction is 0.7 bar (10 psig) and higher.

SUBMERSIBLE APPLICATIONS: Pro-Flo X[™] pumps can be used for submersible applications, when using the Pro-Flo X[™] submersible option. Turbo-Flo[™] pumps can also be used for submersible applications.

NOTE: Pro-Flo[®] and Accu-Flo[™] pumps are not submersible.

ALL WILDEN PUMPS ARE CAPABLE OF PASSING SOLIDS. A STRAINER SHOULD BE USED ON THE PUMP INTAKE TO ENSURE THAT THE PUMP'S RATED SOLIDS CAPACITY IS NOT EXCEEDED.

CAUTION: DO NOT EXCEED 8.6 BAR (125 PSIG) AIR SUPPLY PRESSURE.

SUGGESTED INSTALLATION

This illustration is a generic representation of an air-operated double-diaphragm pump.

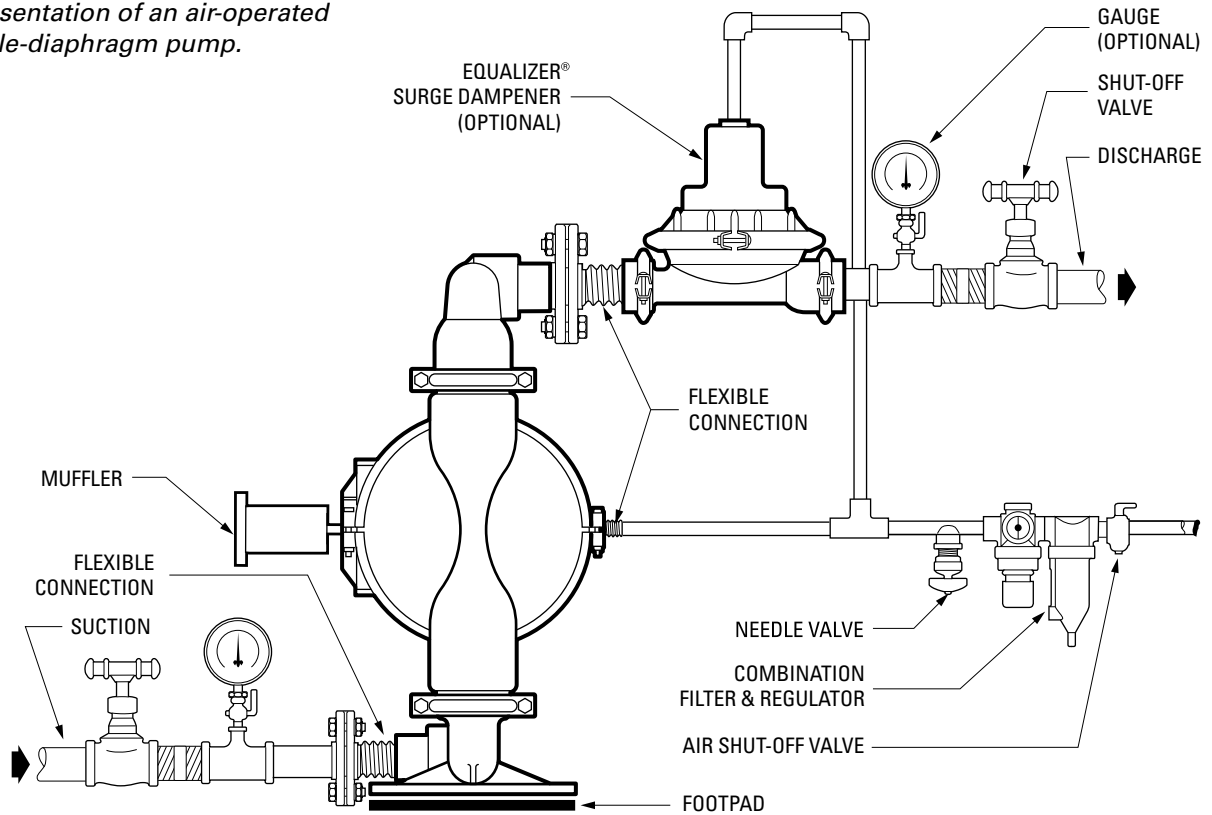

NOTE: In the event of a power failure, the shut-off valve should be closed, if the restarting of the pump is not desirable once power is regained.

AIR-OPERATED PUMPS: To stop the pump from operating in an emergency situation, simply close the

shut-off valve (user-supplied) installed in the air supply line. A properly functioning valve will stop the air supply to the pump, thereby stopping output. This shut-off valve should be located far enough away from the pumping equipment such that it can be reached safely in an emergency situation.

SUGGESTED OPERATION & MAINTENANCE

OPERATION: The PX15 is pre-lubricated, and does not require in-line lubrication. Additional lubrication will not damage the pump, however if the pump is heavily lubricated by an external source, the pump's internal lubrication may be washed away. If the pump is then moved to a non-lubricated location, it may need to be disassembled and re-lubricated as described in the ASSEMBLY/DISASSEMBLY INSTRUCTIONS.

Pump discharge rate can be controlled by limiting the volume and/or pressure of the air supply to the pump. An air regulator is used to regulate air pressure. A needle valve is used to regulate volume. Pump discharge rate can also be controlled by throttling the pump discharge by partially closing a valve in the discharge line of the pump. This action increases friction loss which reduces flow rate. (See Section 5.) This is useful when the need exists to control the pump from a remote location. When the pump discharge pressure equals or exceeds the air supply pressure, the pump will stop; no bypass or pressure relief valve is needed, and pump damage will not occur. The pump has reached a "deadhead" situation

and can be restarted by reducing the fluid discharge pressure or increasing the air inlet pressure. The Wilden PX15 pump runs solely on compressed air and does not generate heat; therefore, your process fluid temperature will not be affected.

MAINTENANCE AND INSPECTIONS: Since each application is unique, maintenance schedules may be different for every pump. Frequency of use, line pressure, viscosity and abrasiveness of process fluid all affect the parts life of a Wilden pump. Periodic inspections have been found to offer the best means for preventing unscheduled pump downtime. Personnel familiar with the pump's construction and service should be informed of any abnormalities that are detected during operation.

RECORDS: When service is required, a record should be made of all necessary repairs and replacements. Over a period of time, such records can become a valuable tool for predicting and preventing future maintenance problems and unscheduled downtime. In addition, accurate records make it possible to identify pumps that are poorly suited to their applications.

TROUBLESHOOTING

Pump will not run or runs slowly.

1. Ensure that the air inlet pressure is at least 0.4 bar (5 psig) above startup pressure and that the differential pressure (the difference between air inlet and liquid discharge pressures) is not less than 0.7 bar (10 psig).
2. Check air inlet filter for debris (see SUGGESTED INSTALLATION).
3. Check for extreme air leakage (blow by) which would indicate worn seals/bores in the air valve, pilot spool, main shaft.
4. Disassemble pump and check for obstructions in the air passageways or objects which would obstruct the movement of internal parts.
5. Check for sticking ball check valves. If material being pumped is not compatible with pump elastomers, swelling may occur. Replace ball check valves and seals with proper elastomers. Also, as the check valve balls wear out, they become smaller and can become stuck in the seats. In this case, replace balls and seats.
6. Check for broken inner piston which will cause the air valve spool to be unable to shift.
7. Remove plug from pilot spool exhaust.

Pump runs but little or no product flows.

1. Check for pump cavitation; slow pump speed down to allow thick material to flow into liquid chambers.

2. Verify that vacuum required to lift liquid is not greater than the vapor pressure of the material being pumped (cavitation).
3. Check for sticking ball check valves. If material being pumped is not compatible with pump elastomers, swelling may occur. Replace ball check valves and seats with proper elastomers. Also, as the check valve balls wear out, they become smaller and can become stuck in the seats. In this case, replace balls and seats.

Pump air valve freezes.

1. Check for excessive moisture in compressed air. Either install a dryer or hot air generator for compressed air. Alternatively, a coalescing filter may be used to remove the water from the compressed air in some applications.

Air bubbles in pump discharge.

1. Check for ruptured diaphragm.
2. Check tightness of outer pistons (refer to Section 7).
3. Check tightness of fasteners and integrity of O-rings and seals, especially at intake manifold.
4. Ensure pipe connections are airtight.

Product comes out air exhaust.

1. Check for diaphragm rupture.
2. Check tightness of outer pistons to shaft.

Tools Required:

- 11/16" Wrench
- 3/4" Wrench
- Adjustable Wrench
- Vise equipped w/ soft jaws (such as plywood, plastic or other suitable material)

CAUTION: Before any maintenance or repair is attempted, the compressed air line to the pump should be disconnected and all air pressure allowed to bleed from the pump. Disconnect all intake, discharge and air lines. Drain the pump by turning it upside down and allowing any fluid to flow into a suitable container. Be aware of any hazardous effects of contact with your process fluid.

NOTE: The model photographed for these instructions incorporates rubber diaphragms, balls and seats. Models with PTFE diaphragms, balls and seats are the same except where noted.

**Step 1.**

Before starting disassembly, mark a line from each liquid chamber to its corresponding air chamber. This line will assist in proper alignment during reassembly.

**Step 2**

Utilizing a 11/16" wrench, remove the two (2) small clamp bands that fasten the discharge manifold to the liquid chambers.

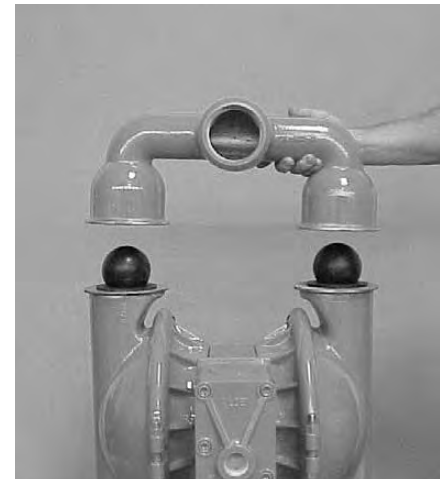
**Step 3**

Remove the discharge manifold to expose the valve balls and seats. Inspect ball cage area of manifold for excessive wear or damage.



Step 4

Remove the discharge valve balls and seats from the liquid chambers and inspect for nicks, chemical attack or abrasive wear. Replace worn parts with genuine Wilden parts for reliable performance.

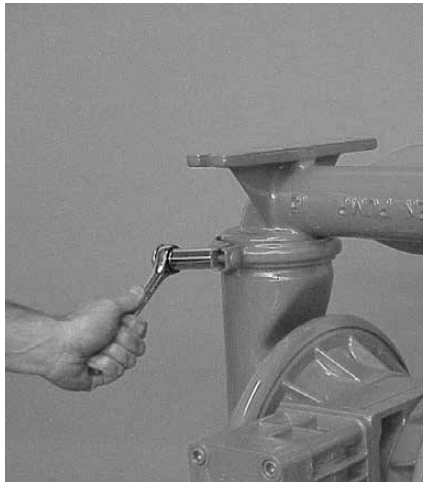

Step 5

Turn pump upside down and remove the two (2) small clamp bands which fasten the intake manifold to the liquid chambers.



Step 6

Lift intake manifold to expose intake valve balls and seats. Inspect ball cage area of liquid chamber for excessive wear or damage.

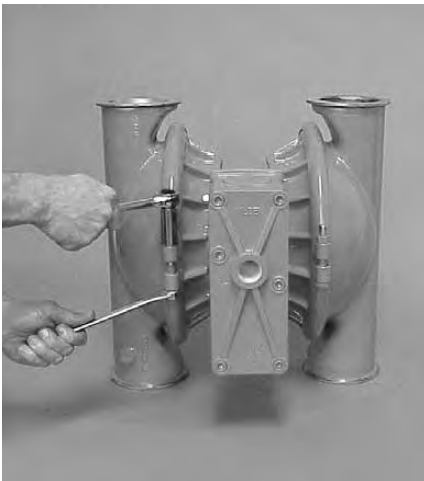

Step 7

Remove one set of large clamp bands which secure one liquid chamber to the center section using two 3/4" wrenches.



Step 8

Lift liquid chamber away from center section to expose diaphragm and outer piston.



Step 9

Using an adjustable wrench, or by rotating the diaphragm by hand, remove the diaphragm assembly.



Step 9A

Due to varying torque values, one of the following two situations may occur: 1) The outer piston, diaphragm and inner piston remain attached to the shaft and the entire assembly can be removed from the center section.

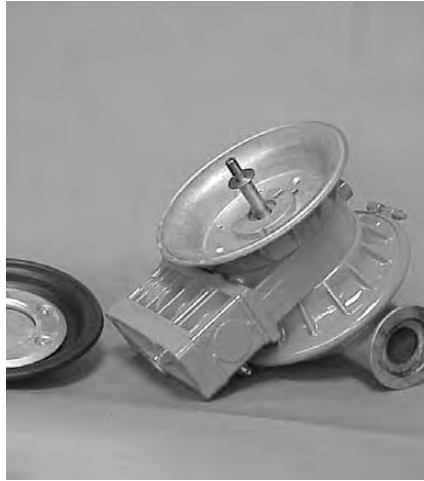

Step 9B

2) The outer piston, diaphragm and inner piston separate from the shaft which remains connected to the opposite side diaphragm assembly (Figure 9B). Repeat disassembly instructions for the opposite liquid chamber. Inspect diaphragm assembly and shaft for signs of wear or chemical attack. Replace all worn parts with genuine Wilden parts for reliable performance.



Step 10

To remove diaphragm assembly from shaft, secure shaft with soft jaws (a vise fitted with plywood, plastic, or other suitable material) to ensure shaft is not nicked, scratched or gouged. Using an adjustable wrench, remove diaphragm assembly from shaft.

AIR VALVE / CENTER SECTION DISASSEMBLY

Tools Required:

Pro-Flo X™

- 3/16" Hex Head Wrench
- 1/4" Hex Head Wrench
- Snap-Ring Pliers
- O-Ring Pick

CAUTION: Before any maintenance or repair is attempted, the compressed air line to the pump should be disconnected and all air pressure allowed to bleed from the pump. Disconnect all intake, discharge and air lines. Drain the pump by turning it upside down and allowing any fluid to flow into a suitable container. Be aware of hazardous effects of contact with your process fluid.

The Wilden PX15 metal pump utilizes a revolutionary Pro-Flo X air distribution system. Proprietary composite seals reduce the coefficient of friction and allow lube-free operation. The Pro-Flo X air distribution system is designed to perform in on/off, non-freezing, non-stalling, tough duty applications.



Step 1

Loosen the air valve bolts utilizing a 3/8" hex head wrench.



Step 2

Remove muffer plate and air valve bolts from air valve assembly exposing muffer gasket for inspection. Replace, if necessary.



Step 3

Lift away air valve assembly and remove air valve gasket for inspection. Replace, if necessary.

AIR VALVE / CENTER SECTION DISASSEMBLY



Step 4

Remove air valve end cap to expose air valve spool by simply lifting up on end cap once air valve bolts are removed.



Step 5

Remove air valve spool from air valve body by threading one air valve bolt into the end of the spool and gently sliding the spool out of the air valve body. Inspect seals for signs of wear and replace entire assembly if necessary. Use caution when handling air valve spool to prevent damaging seals.

NOTE: Seals should not be removed from assembly. Seals are not sold separately.



Step 6

Remove pilot spool retaining snap-ring on both sides of center section with snap-ring pliers.



Step 7

Remove air chamber bolts with 1/4" hex head wrench.



Step 8

Remove pilot spool bushing from center block.



Step 9

With O-ring pick, gently remove the O-ring from the opposite side of the notched end of the spool. Gently remove the pilot spool from sleeve and inspect for nicks or gouges and other signs of wear. replace pilot sleeve assembly or outer sleeve O-rings if necessary. During re-assembly never insert the pilot spool into the sleeve with the "notched" end side first, this end incorporates the urethane O-ring and will be damaged as it slides over the ports cut in the sleeve.

NOTE: Seals should not be removed from pilot spool. Seals are not sold separately.

WILDEN PUMP & ENGINEERING, LLC

AIR VALVE / CENTER SECTION DISASSEMBLY



Step 10

Check center block seals for signs of wear. If necessary, remove shaft seals with O-ring pick and replace.

SUBMERSIBLE PRO-FLO X™

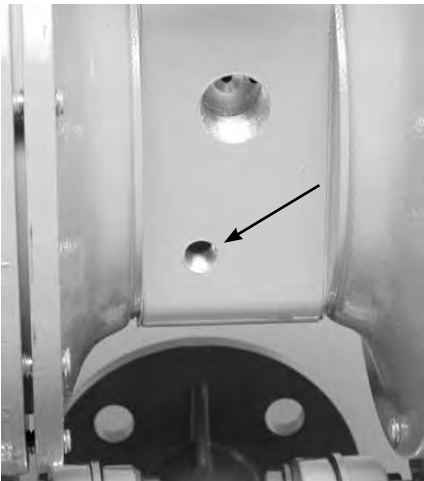

Step 1

Install a 6 mm (1/4") NPT pipe plug (00-7010-08) into the pilot spool bleed port located at the front of the center block.

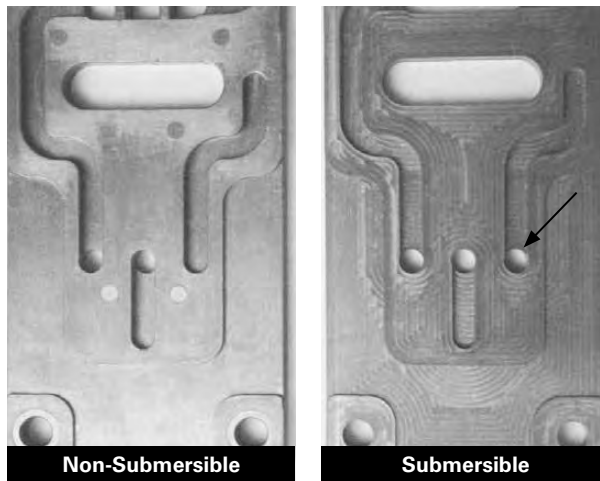

Step 2

Next, install an optional submersible air valve gasket (04-2621-52). The submersible air valve gasket can be purchased as a spare part or included with the purchase of a new Pro-Flo X™ pump.

ASSEMBLY:

Upon performing applicable maintenance to the air distribution system, the pump can now be reassembled. Please refer to the disassembly instructions for photos and parts placement. To reassemble the pump, follow the disassembly instructions in reverse order. The air distribution system needs to be assembled first, then the diaphragms and finally the wetted path. Please find the applicable torque specifications on this page. The following tips will assist in the assembly process.

- Lubricate air valve bore, center section shaft and pilot spool bore with NLGI grade 2 white EP grease or equivalent.
- Clean the inside of the center section shaft bushing to ensure no damage is done to new shaft seals.
- A small amount of NLGI grade 2 white EP grease can be applied to the muffler and air valve gaskets to locate gaskets during assembly.
- Make sure that the exhaust port on the muffler plate is centered between the two exhaust ports on the center section.
- Stainless bolts should be lubed to reduce the possibility of seizing during tightening.
- Use a mallet to tamp lightly on the large clamp bands to seat the diaphragm before tightening.

PRO-FLO X™ MAXIMUM TORQUE SPECIFICATIONS

Description of Part	Torque
Air Valve	13.6 N•m (120 in-lb)
Air Chamber/Center Block	27.1 N•m (20 ft-lb)
Inner Piston Ring	19.0 N•m (14 ft-lb)
Outer Pistons, Rubber & PTFE	136 N•m (100 ft-lb)
Outer Pistons, Ultra-Flex™	136 N•m (100 ft-lb)
Small Clamp Bands	15.5 N•m (137 in-lb)
Large Clamp Bands (Rubber-Fitted)	61.0 N•m (45 ft-lb)
Large Clamp Bands (PTFE-Fitted)	61.0 N•m (45 ft-lb)

SHAFT SEAL INSTALLATION:

PRE-INSTALLATION

- Once all of the old seals have been removed, the inside of the bushing should be cleaned to ensure no debris is left that may cause premature damage to the new seals.

INSTALLATION

The following tools can be used to aid in the installation of the new seals:

Needle Nose Pliers
Phillips Screwdriver
Electrical Tape

- Wrap electrical tape around each leg of the needle nose pliers (heat shrink tubing may also be used). This is done to prevent damaging the inside surface of the new seal.
- With a new seal in hand, place the two legs of the needle nose pliers inside the seal ring. (See Figure A.)
- Open the pliers as wide as the seal diameter will allow, then with two fingers pull down on the top portion of the seal to form kidney bean shape. (See Figure B.)
- Lightly clamp the pliers together to hold the seal into the kidney shape. Be sure to pull the seal into as tight of a kidney shape as possible, this will allow the seal to travel down the bushing bore easier.
- With the seal clamped in the pliers, insert the seal into the bushing bore and position the bottom of the seal into the correct groove. Once the bottom of the seal is seated in the groove, release the clamp pressure on the pliers. This will allow the seal to partially snap back to its original shape.
- After the pliers are removed, you will notice a slight bump in the seal shape. Before the seal can be properly resized, the bump in the seal should be removed as much as possible. This can be done with either the Phillips screwdriver or your finger. With either the side of the screwdriver or your finger, apply light pressure to the peak of the bump. This pressure will cause the bump to be almost completely eliminated.
- Lubricate the edge of the shaft with NLGI grade 2 white EP bearing grease.
- Slowly insert the center shaft with a rotating motion. This will complete the resizing of the seal.
- Perform these steps for the remaining seals.

Figure A

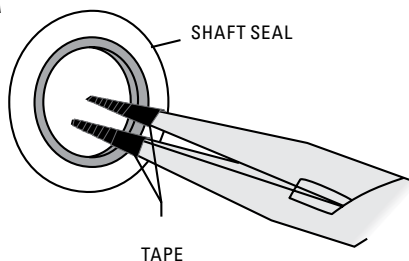
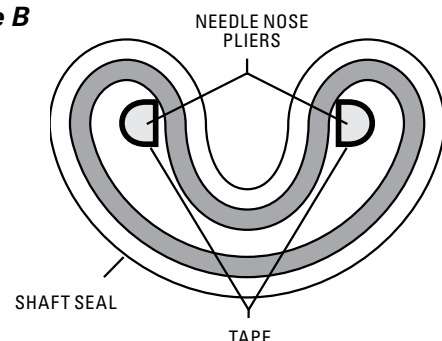

Figure B





EXPLODED VIEW & PARTS LISTING

PX15 METAL

Full-Stroke Diaphragm-Fitted

EXPLODED VIEW

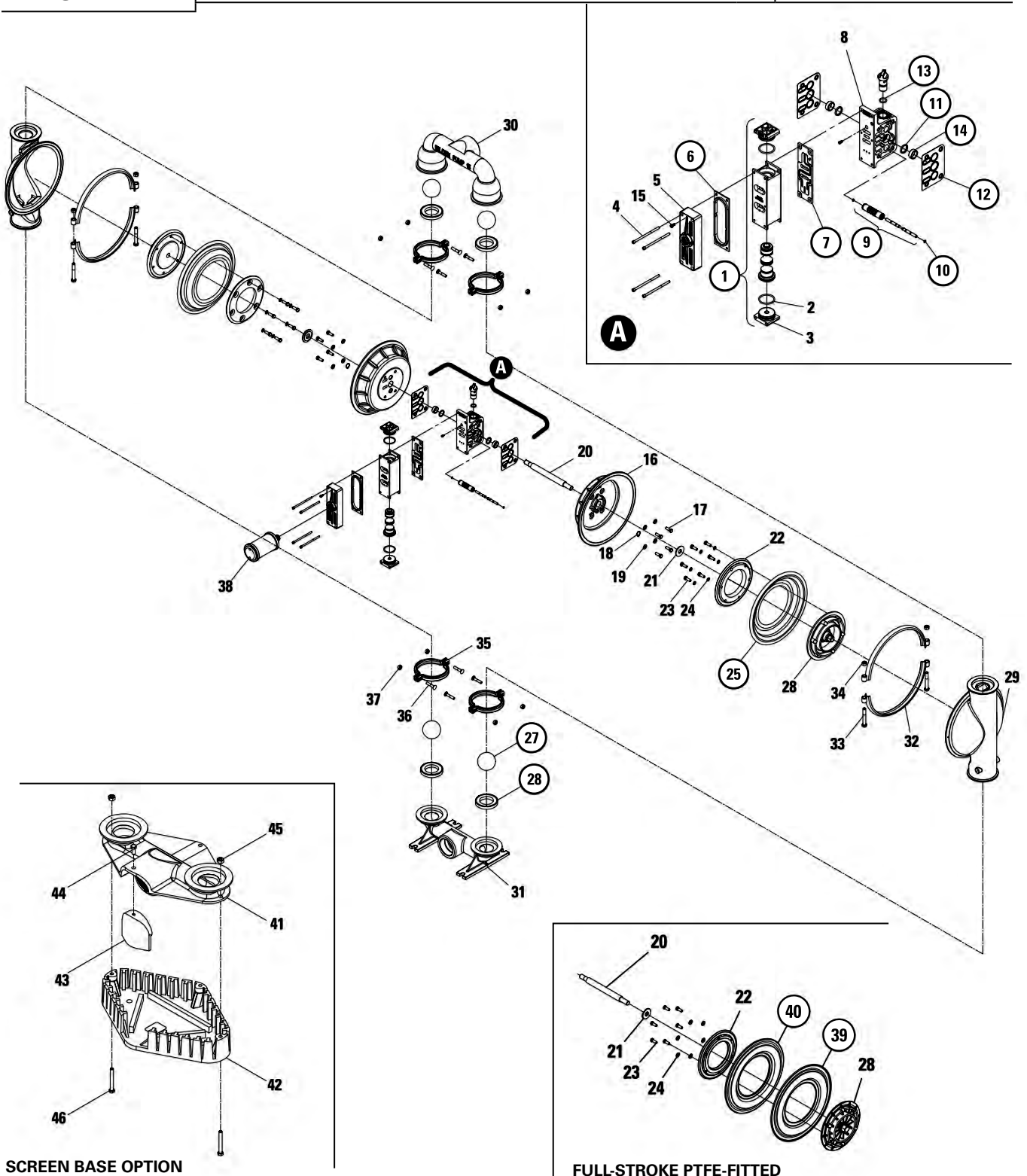

SCREEN BASE OPTION

FULL-STROKE PTFE-FITTED

ALL CIRCLED PART IDENTIFIERS ARE INCLUDED IN REPAIR KITS (see Section 9).



EXPLODED VIEW & PARTS LISTING

PX15 METAL

Full-Stroke Diaphragm-Fitted

PARTS LISTING

Item	Description	Qty.	PX15/AAAA/ P/N	PX15/WWAAA/ P/N	PX15/SSAAA/ P/N	PX15/SSAAA/0070 P/N	PX15/SSSSS/ P/N	PX15/SSSSS/0070 P/N
1	Pro-Flo V™ Assembly, Air Valve ¹	1	04-2030-01	04-2030-01	04-2030-01	04-2030-01	04-2030-03	04-2030-03
2	O-Ring (-225), End Cap (Ø1.859" x Ø.139")	2	04-2390-52-700	04-2390-52-700	04-2390-52-700	04-2390-52-700	04-2390-52-700	04-2390-52-700
3	End Cap	2	04-2340-01	04-2340-01	04-2340-01	04-2340-01	04-2340-03	04-2340-03
4	Screw, SHC, Air Valve (1/4"-20 x 4-1/2")	4	01-6000-03	01-6000-03	01-6000-03	01-6000-03	01-6000-03	01-6000-03
5	Muffler Plate, Pro-Flo V™	1	04-3185-01	04-3185-01	04-3185-01	04-3185-01	04-3185-03	04-3185-03
6	Gasket, Muffler Plate, Pro-Flo V™	1	04-3502-52	04-3502-52	04-3502-52	04-3502-52	04-3502-52	04-3502-52
7	Gasket, Air Valve, Pro-Flo V™	1	04-2620-52	04-2620-52	04-2620-52	04-2620-52	04-2620-52	04-2620-52
8	Center Block Assembly, Pro-Flo X™ ²	1	15-3126-01	15-3126-01	15-3126-01	15-3126-01	15-3126-03	15-3126-03
9	Pilot Sleeve Assembly	1	15-3884-99	15-3884-99	15-3884-99	15-3884-99	15-3884-99	15-3884-99
10	Pilot Spool Retaining O-Ring	2	04-2650-49-700	04-2650-49-700	04-2650-49-700	04-2650-49-700	04-2650-49-700	04-2650-49-700
11	Shaft Seal	2	15-3210-55-225	15-3210-55-225	15-3210-55-225	15-3210-55-225	15-3210-55-225	15-3210-55-225
12	Gasket, Center Block Pro-Flo V™	2	04-3529-52	04-3529-52	04-3529-52	04-3529-52	04-3529-52	04-3529-52
13	O-Ring (-210), Adjuster (Ø.734" x Ø.139")	1	02-3200-52	02-3200-52	02-3200-52	02-3200-52	02-3200-52	02-3200-52
14	Bushing, Shaft	2	15-3306-13	15-3306-13	15-3306-13	15-3306-13	15-3306-13	15-3306-13
15	Ground Screw, 10-32 x .50" Self Tapping	1	04-6345-08	04-6345-08	04-6345-08	04-6345-08	04-6345-08	04-6345-08
16	Air Chamber, Pro-Flo	2	15-3660-01	15-3660-01	15-3660-01	15-3660-01	15-3660-03	15-3660-03
17	Screw, HHC (3/8" - 16 x 1-1/8")	8	15-6130-08	15-6130-08	15-6130-08	15-6130-08	15-6130-03	15-6130-03
18	Retaining Ring	2	04-3890-03	04-3890-03	04-3890-03	04-3890-03	04-3890-03	04-3890-03
19	Washer, Flat (Ø.406" x Ø.812" x .065")	8	15-6740-08-50	15-6740-08-50	15-6740-08-50	15-6740-08-50	15-6740-08-50	15-6740-08-50
20	Shaft	1	15-3805-09	15-3805-09	15-3805-09	15-3805-09	15-3805-09	15-3805-09
21	Washer, Inner Piston Back-up	2	15-6850-08	15-6850-08	15-6850-08	15-6850-08	15-6850-08	15-6850-08
22	Piston, Inner	2	15-3700-01	15-3700-01	15-3700-01	15-3700-01	15-3700-03	15-3700-03
23	Outer Piston Bolt (3/8" - 16 x 1-1/8")	12	15-6130-08	15-6130-08	15-6130-03	15-6130-03	15-6130-03	15-6130-03
24	Washer, Flat (Ø.406" x Ø.812" x .065")	12	15-6740-08-50	15-6740-08-50	15-6740-03-50	15-6740-03-50	15-6740-03-50	15-6740-03-50
25	Diaphragm	2	*	*	*	15-1010-56	*	15-1010-56
26	Piston, Outer	2	15-4550-01	15-4550-02	15-4550-03	15-4550-03P	15-4550-03	15-4550-03P
27	Ball, Valve	4	*	*	*	15-1080-56	*	15-1080-56
28	Seat, Valve	4	*	*	*	15-1120-56	*	15-1120-56
29	Liquid Chamber	2	15-5000-01	15-5000-02	15-5000-03	15-5000-03P	15-5000-03	15-5000-03P
30	Manifold, Discharge	1	15-5020-01	15-5020-02	15-5020-03	15-5020-03-70P	15-5020-03	15-5020-03-70P
31	Manifold, Footed Inlet	1	15-5080-01	15-5080-02	15-5080-03	15-5080-03-70P	15-5080-03	15-5080-03-70P
32	Large Clamp Band Assembly	2	15-7300-08	15-7300-08	15-7300-03	15-7300-03-70	15-7300-03	15-7300-03-70
33	Large Hex Bolt (1/2" - 13 x 3-1/2")	4	15-6120-08	15-6120-08	15-6120-03	15-6120-03	15-6120-03	15-6120-03
34	Large Hex Nut (1/2" - 13)	4	15-6420-08	15-6420-08	15-6420-03	15-6671-10	15-6420-03	15-6671-10
35	Small Clamp Band Assembly	4	15-7100-08	15-7100-08	15-7100-03	15-7100-03-70	15-7100-03	15-7100-03-70
36	Small Hex Bolt (3/8" - 16 x 2-1/4") ³	8	15-6050-08	15-6050-08	15-6050-03	15-6050-03	15-6050-03	15-6050-03
37	Small Hex Nut (3/8" - 16)	8	08-6450-08	08-6450-08	08-6450-03	08-6671-10	08-6450-03	08-6671-10
38	Muffler	1	15-3510-99R	15-3510-99R	15-3510-99R	15-3510-99R	15-3510-99R	15-3510-99R
39	Diaphragm, Full Stroke PTFE, Primary	2	15-1040-55	15-1040-55	15-1040-55	15-1040-55	15-1040-55	15-1040-55
40	Diaphragm, Full Stroke PTFE, Back-Up	2	*	*	*	*	*	*
	Washer, Flat, (Ø.392" x Ø.875" x .062") (Not Shown)	8	N/A	N/A	N/A	08-6720-07-70	N/A	08-6720-07-70
	Washer, Flat, (Ø.516" x Ø.875" x .063") (Not Shown)	4	N/A	N/A	N/A	15-6720-07-70	N/A	15-6720-07-70

Screen Base Assembly - / 0030 Specialty Code

Item	Description	Qty.	/0030 P/N
41	Manifold, Inlet	1	15-5080-01-30
42	Screen Base	1	15-5620-01
43	Suction Hook-up Cover	1	15-5660-01
44	Hex Machine Screw (3/8" - 16 x 7/8")	1	08-6140-08
45	Hex Nut (3/8" - 16)	2	08-6430-08
46	Hex Machine Screw (3/8" - 16 x 3")	2	08-6120-08

*See elastomer chart - Section 9

¹Air Valve Assembly includes items 2 and 3.

²Center Block Assembly includes items 11, 13 and 14.

0030 Specialty Code = Screen Based

0070 Specialty Code = Saniflo™ FDA

All boldface items are primary wear parts.

EXPLODED VIEW & PARTS LISTING

PX15 METAL

Reduced-Stroke Diaphragm-Fitted

EXPLODED VIEW

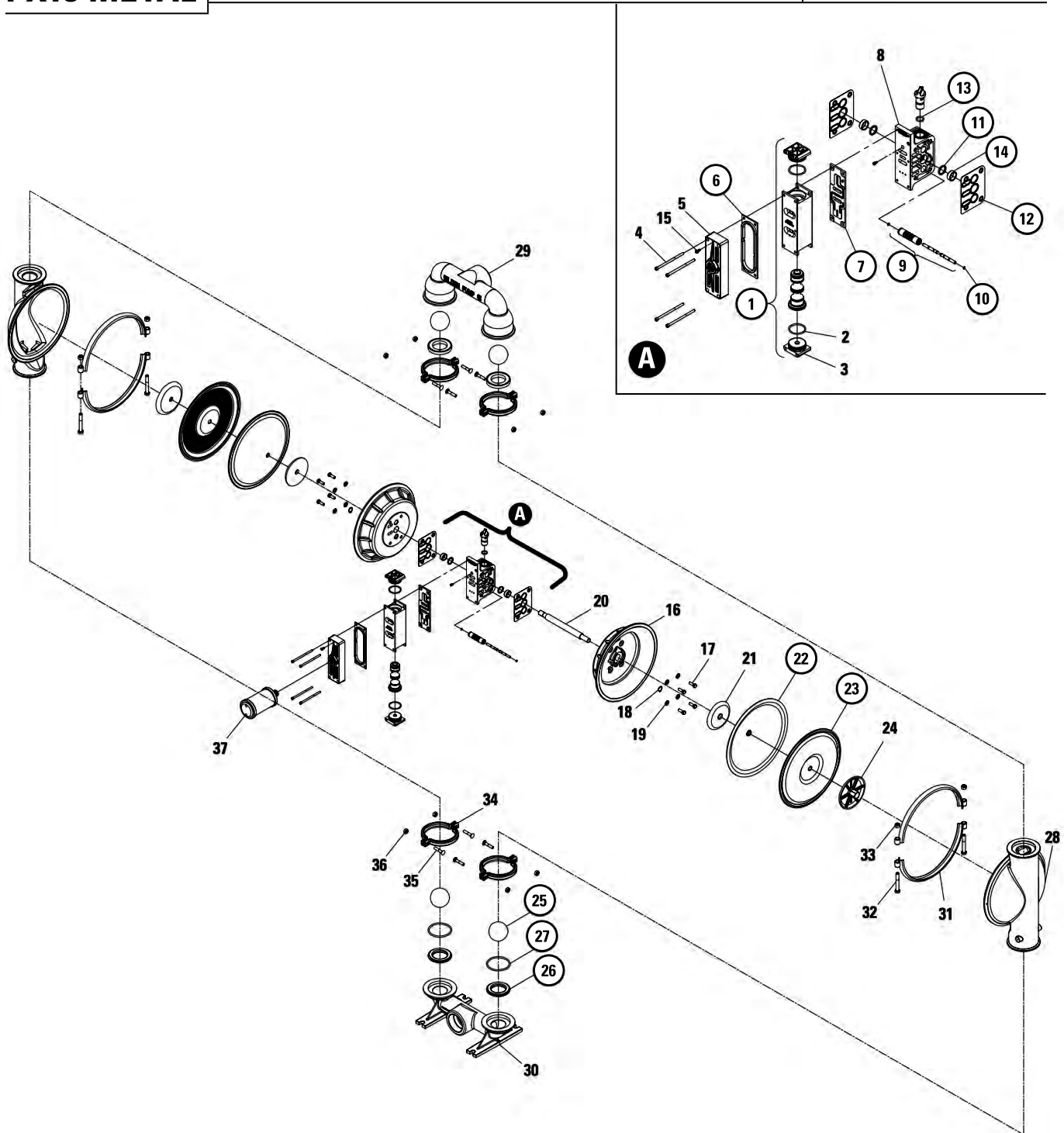

ALL CIRCLED PART IDENTIFIERS ARE INCLUDED IN REPAIR KITS (see Section 9).



EXPLODED VIEW & PARTS LISTING



PX15 METAL

Reduced-Stroke Diaphragm-Fitted

PARTS LISTING

Item	Description	Qty.	PX15/AAAAA/ P/N	PX15/WWAAA/ P/N	PX15/SSAAA/ P/N	PX15/SSAAA/0070 P/N	PX15/SSSSS/ P/N	PX15/SSSSS/0070 P/N
1	Pro-Flo V™ Assembly, Air Valve ¹	1	04-2030-01	04-2030-01	04-2030-01	04-2030-01	04-2030-03	04-2030-03
2	O-Ring (-225), End Cap (Ø1.859" x Ø.139")	2	04-2390-52-700	04-2390-52-700	04-2390-52-700	04-2390-52-700	04-2390-52-700	04-2390-52-700
3	End Cap	2	04-2340-01	04-2340-01	04-2340-01	04-2340-01	04-2340-03	04-2340-03
4	Screw, SHC, Air Valve (1/4" -20 x 4-1/2")	4	01-6000-03	01-6000-03	01-6000-03	01-6000-03	01-6000-03	01-6000-03
5	Muffler Plate, Pro-Flo V™	1	04-3185-01	04-3185-01	04-3185-01	04-3185-01	04-3185-03	04-3185-03
6	Gasket, Muffler Plate, Pro-Flo V™	1	04-3502-52	04-3502-52	04-3502-52	04-3502-52	04-3502-52	04-3502-52
7	Gasket, Air Valve, Pro-Flo V™	1	04-2620-52	04-2620-52	04-2620-52	04-2620-52	04-2620-52	04-2620-52
8	Center Block Assembly, Pro-Flo X™ ²	1	15-3126-01	15-3126-01	15-3126-01	15-3126-01	15-3126-03	15-3126-03
9	Pilot Sleeve Assembly	1	15-3884-99	15-3884-99	15-3884-99	15-3884-99	15-3884-99	15-3884-99
10	Pilot Spool Retaining O-Ring	2	04-2650-49-700	04-2650-49-700	04-2650-49-700	04-2650-49-700	04-2650-49-700	04-2650-49-700
11	Shaft Seal	2	15-3210-55-225	15-3210-55-225	15-3210-55-225	15-3210-55-225	15-3210-55-225	15-3210-55-225
12	Gasket, Center Block Pro-Flo V™	2	04-3529-52	04-3529-52	04-3529-52	04-3529-52	04-3529-52	04-3529-52
13	O-Ring (-210), Adjuster (Ø.734" x Ø.139")	1	02-3200-52	02-3200-52	02-3200-52	02-3200-52	02-3200-52	02-3200-52
14	Bushing, Shaft	2	15-3306-13	15-3306-13	15-3306-13	15-3306-13	15-3306-13	15-3306-13
15	Ground Screw, 10-32 x .50" Self Tapping	1	04-6345-08	04-6345-08	04-6345-08	04-6345-08	04-6345-08	04-6345-08
16	Air Chamber, Pro-Flo	2	15-3660-01	15-3660-01	15-3660-01	15-3660-01	15-3660-03	15-3660-03
17	Screw, HHC (3/8" -16 x 1-1/8")	8	15-6130-08	15-6130-08	15-6130-08	15-6130-08	15-6130-03	15-6130-03
18	Retaining Ring	2	04-3890-03	04-3890-03	04-3890-03	04-3890-03	04-3890-03	04-3890-03
19	Washer, Flat (Ø.406" x Ø.812" x .065")	8	15-6740-08-50	15-6740-08-50	15-6740-08-50	15-6740-08-50	15-6740-08-50	15-6740-08-50
20	Shaft	1	15-3805-09	15-3805-09	15-3805-09	15-3805-09	15-3805-09	15-3805-09
21	Piston, Inner	2	15-3750-01	15-3750-01	15-3750-01	15-3750-01	15-3752-03	15-3752-03
	Piston Inner, Ultra-Flex™	2	15-3760-08	15-3760-08	15-3760-08	N/A	15-3760-08	N/A
22	Back-up Diaphragm	2	*	*	*	*	*	*
23	Diaphragm	2	15-1010-55	15-1010-55	15-1010-55	15-1010-55	15-1010-55	15-1010-55
	Ultra-Flex™	2	*	*	*	*	*	*
24	Piston, Outer	2	15-4600-03	15-4600-03	15-4600-03	15-4600-03P	15-4600-03	15-4600-03P
	Piston Outer, Ultra-Flex™	2	15-4560-01	15-4560-02	15-4560-03	N/A	15-4560-03	N/A
25	Ball, Valve	4	15-1080-55	15-1080-55	15-1080-55	15-1080-55	15-1080-55	15-1080-55
26	Seat, Valve	4	15-1121-01	15-1121-08	15-1121-03	15-1121-03P	15-1121-03	15-1121-03P
27	PTFE Valve Seat O-Ring	4	15-1200-55	15-1200-55	15-1200-55	15-1200-55	15-1200-55	15-1200-55
28	Liquid Chamber	2	15-5000-01	15-5000-02	15-5000-03	15-5000-03P	15-5000-03	15-5000-03P
29	Manifold, Discharge	1	15-5020-01	15-5020-02	15-5020-03	15-5020-03-70P	15-5020-03	15-5020-03-70P
30	Manifold, Footed Inlet	1	15-5080-01	15-5080-02	15-5080-03	15-5080-03-70P	15-5080-03	15-5080-03-70P
31	Large Clamp Band Assembly	2	15-7300-03	15-7300-03	15-7300-03	15-7300-03-70	15-7300-03	15-7300-03-70
32	Large Hex Bolt (1/2" -13 x 3-1/2")	4	15-6120-03	15-6120-03	15-6120-03	15-6120-03	15-6120-03	15-6120-03
33	Large Hex Nut (1/2" -13)	4	15-6420-03	15-6420-03	15-6420-03	15-6671-10	15-6420-03	15-6671-10
34	Small Clamp Band Assembly	4	15-7100-03	15-7100-03	15-7100-03	15-7100-03-70	15-7100-03	15-7100-03-70
35	Small Hex Bolt (3/8" -16 x 2")	8	15-6050-03	15-6050-03	15-6050-03	15-6050-03	15-6050-03	15-6050-03
36	Small Hex Nut (3/8" -16)	8	08-6450-03	08-6450-03	08-6450-03	08-6671-10	08-6450-03	08-6671-10
37	Muffler	1	15-3510-99R	15-3510-99R	15-3510-99R	15-3510-99R	15-3510-99R	15-3510-99R
	Washer, Flat, (Ø.392" x Ø.875" x .062") (Not Shown)	8	N/A	N/A	N/A	08-6720-07-70	N/A	08-6720-07-70
	Washer, Flat, (Ø.516" x Ø.875" x .063") (Not Shown)	4	N/A	N/A	N/A	15-6720-07-70	N/A	15-6720-07-70

*See elastomer chart - Section 9

¹Air Valve Assembly includes items 2 and 3.

²Center Block Assembly includes items 11, 13 and 14.

0070 Specialty Code = Saniflo™ FDA

All boldface items are primary wear parts.

EXPLODED VIEW & PARTS LISTING

PX15 METAL

Full-Stroke Diaphragm-Fitted (Plastic Center Block Assm.)

EXPLODED VIEW

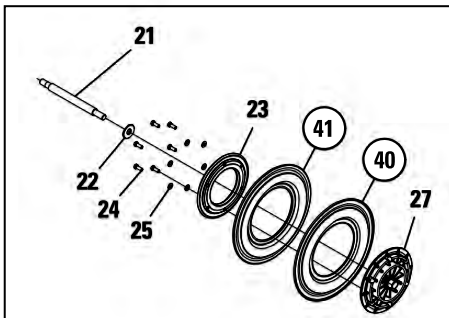
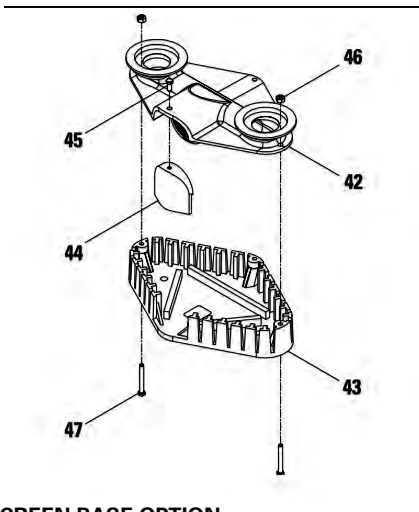
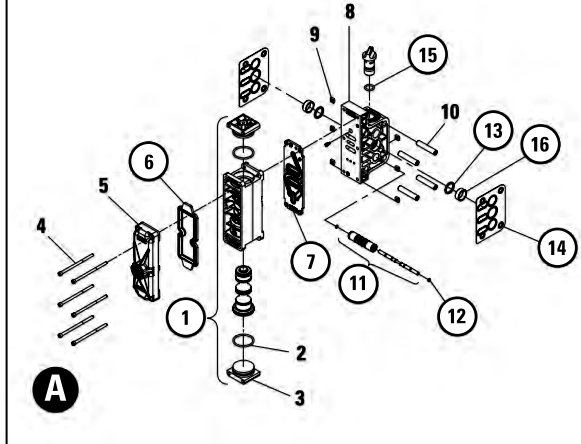
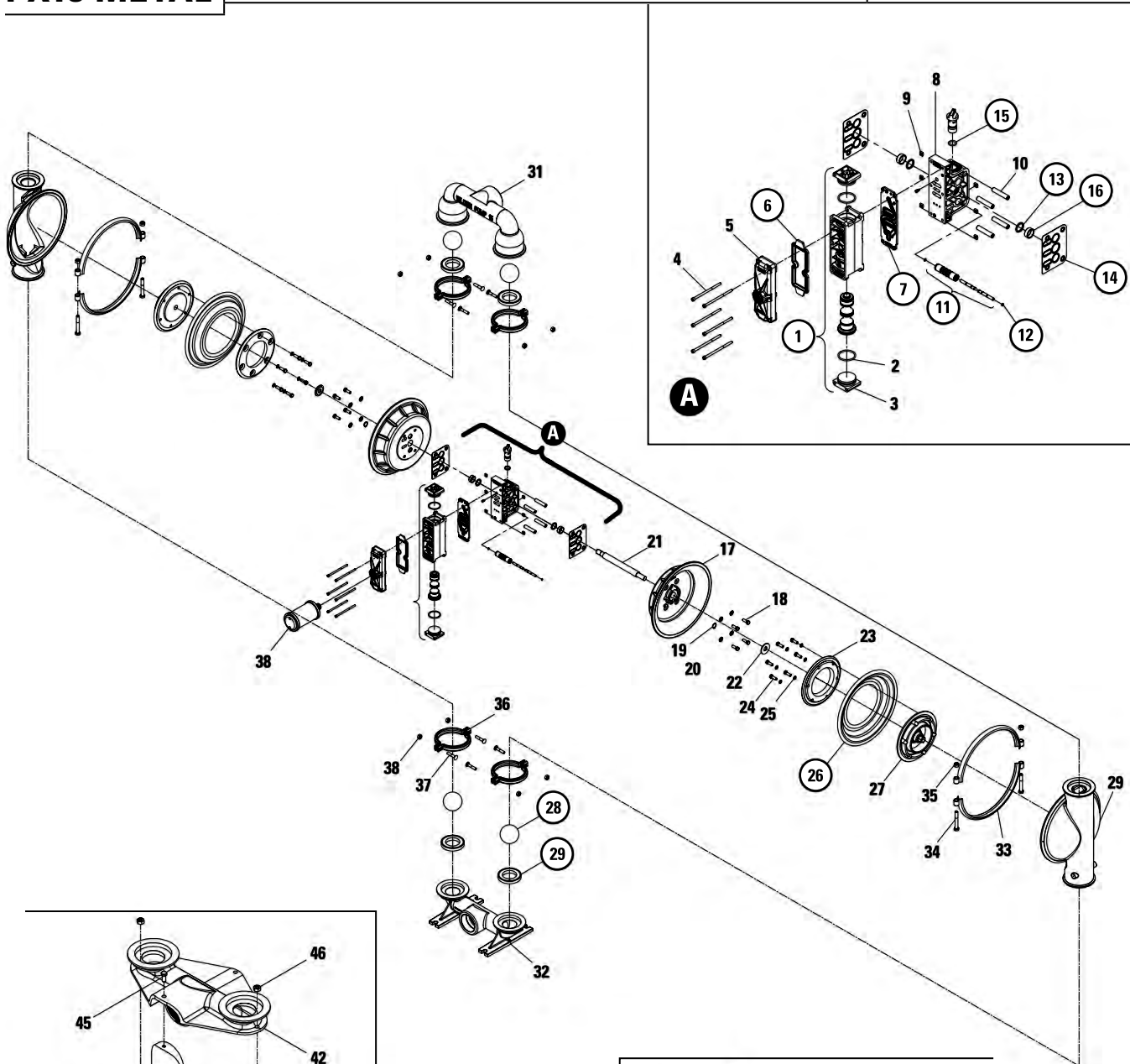

SCREEN BASE OPTION

FULL-STROKE PTFE-FITTED



EXPLODED VIEW & PARTS LISTING

PX15 METAL Full-Stroke Diaphragm-Fitted (Plastic Center Block Assm.) PARTS LISTING

Item	Description	Qty.	PX15/AAAPP/ P/N	PX15/WWWPP/ P/N	PX15/SSAPP/ P/N	PX15/SSAPP/0070 P/N	PX15/SSSPP/ P/N	PX15/SSSPP/0070 P/N
1	Pro-Flo V™ Assembly, Air Valve ¹	1	08-2030-20	08-2030-20	08-2030-20	08-2030-20	08-2030-20	08-2030-20
2	O-Ring (-225), End Cap (Ø1.859" x Ø.139")	2	04-2390-52-700	04-2390-52-700	04-2390-52-700	04-2390-52-700	04-2390-52-700	04-2390-52-700
3	End Cap	2	04-2330-20-700	04-2330-20-700	04-2330-20-700	04-2330-20-700	04-2330-20-700	04-2330-20-700
4	Screw, SHC, Air Valve (1/4"-20 x 4-1/2")	6	01-6000-03	01-6000-03	01-6000-03	01-6000-03	01-6000-03	01-6000-03
5	Muffler Plate, Pro-Flo V™	1	08-3185-20	08-3185-20	08-3185-20	08-3185-20	08-3185-20	08-3185-20
6	Gasket, Muffler Plate, Pro-Flo V™	1	08-3502-52	08-3502-52	08-3502-52	08-3502-52	08-3502-52	08-3502-52
7	Gasket, Air Valve, Pro-Flo V™	1	08-2620-52	08-2620-52	08-2620-52	08-2620-52	08-2620-52	08-2620-52
8	Center Block Assembly, Pro-Flo X™ ²	1	15-3126-20	15-3126-20	15-3126-20	15-3126-20	15-3126-20	15-3126-20
9	Nut, Square, 1/4" -20	6	00-6505-03	00-6505-03	00-6505-03	00-6505-03	00-6505-03	00-6505-03
10	Sleeve, Threaded, C-Blk, Pro-Flo	4	04-7710-08	04-7710-08	04-7710-08	04-7710-08	04-7710-08	04-7710-08
11	Pilot Sleeve Assembly	1	15-3884-99	15-3884-99	15-3884-99	15-3884-99	15-3884-99	15-3884-99
12	Pilot Spool Retaining O-Ring	2	04-2650-49-700	04-2650-49-700	04-2650-49-700	04-2650-49-700	04-2650-49-700	04-2650-49-700
13	Shaft Seal	2	15-3210-55-225	15-3210-55-225	15-3210-55-225	15-3210-55-225	15-3210-55-225	15-3210-55-225
14	Gasket, Center Block Pro-Flo V™	2	04-3529-52	04-3529-52	04-3529-52	04-3529-52	04-3529-52	04-3529-52
15	O-Ring (-210), Adjuster (Ø.734" x Ø.139")	1	02-3200-52	02-3200-52	02-3200-52	02-3200-52	02-3200-52	02-3200-52
16	Bushing, Shaft	2	15-3306-13	15-3306-13	15-3306-13	15-3306-13	15-3306-13	15-3306-13
17	Air Chamber, Pro-Flo	2	15-3660-01	15-3660-02	15-3660-01	15-3660-01	15-3660-03	15-3660-03
18	Screw, HHC (3/8" -16 x 1-1/8")	8	15-6130-08	15-6130-08	15-6130-08	15-6130-08	15-6130-03	15-6130-03
19	Retaining Ring	2	04-3890-03	04-3890-03	04-3890-03	04-3890-03	04-3890-03	04-3890-03
20	Washer, Flat (Ø.406" x Ø.812" x .065")	8	15-6740-08-50	15-6740-08-50	15-6740-08-50	15-6740-08-50	15-6740-03-50	15-6740-03-50
21	Shaft	1	15-3805-09	15-3805-09	15-3805-09	15-3805-09	15-3805-09	15-3805-09
22	Washer, Inner Piston Back-up	2	15-6850-08	15-6850-08	15-6850-08	15-6850-08	15-6850-08	15-6850-08
23	Piston, Inner	2	15-3700-01	15-3700-01	15-3700-01	15-3700-01	15-3700-03	15-3700-03
24	Outer Piston Bolt (3/8" - 16 x 1-1/18")	12	15-6130-08	15-6130-08	15-6130-03	15-6130-03	15-6130-03	15-6130-03
25	Washer, Flat (Ø.406" x Ø.812" x .065")	12	15-6740-08-50	15-6740-08-50	15-6740-03-50	15-6740-03-50	15-6740-03-50	15-6740-03-50
26	Diaphragm	2	*	*	*	15-1010-56	*	15-1010-56
27	Piston, Outer	2	15-4550-01	15-4550-02	15-4550-03	15-4550-03P	15-4550-03	15-4550-03P
28	Ball, Valve	4	*	*	*	15-1080-56	*	15-1080-56
29	Seat, Valve	4	*	*	*	15-1120-56	*	15-1120-56
30	Liquid Chamber	2	15-5000-01	15-5000-02	15-5000-03	15-5000-03P	15-5000-03	15-5000-03P
31	Manifold, Discharge	1	15-5020-01	15-5020-02	15-5020-03	15-5020-03-70P	15-5020-03	15-5020-03-70P
32	Manifold, Footed Inlet	1	15-5080-01	15-5080-02	15-5080-03	15-5080-03-70P	15-5080-03	15-5080-03-70P
33	Large Clamp Band Assembly	2	15-7300-08	15-7300-08	15-7300-03	15-7300-03-70	15-7300-03	15-7300-03-70
34	Large Hex Bolt (1/2" -13 x 3-1/2")	4	15-6120-08	15-6120-08	15-6120-03	15-6120-03	15-6120-03	15-6120-03
35	Large Hex Nut (1/2"-13)	4	15-6420-08	15-6420-08	15-6420-03	15-6671-10	15-6420-03	15-6671-10
36	Small Clamp Band Assembly	4	15-7100-08	15-7100-08	15-7100-03	15-7100-03-70	15-7100-03	15-7100-03-70
37	Small Hex Bolt (3/8" -16 x 2-1/4") ³	8	15-6050-08	15-6050-08	15-6050-03	15-6050-03	15-6050-03	15-6050-03
38	Small Hex Nut (3/8"-16)	8	08-6450-08	08-6450-08	08-6450-03	08-6671-10	08-6450-03	08-6671-10
39	Muffler	1	15-3510-99R	15-3510-99R	15-3510-99R	15-3510-99R	15-3510-99R	15-3510-99R
40	Diaphragm, Full Stroke PTFE, Primary	2	15-1040-55	15-1040-55	15-1040-55	15-1040-55	15-1040-55	15-1040-55
41	Diaphragm, Full Stroke PTFE, Back-Up	2	*	*	*	*	*	*
	Washer, Flat, (Ø.392" x Ø.875" x .062") (Not Shown)	8	N/A	N/A	N/A	08-6720-07-70	N/A	08-6720-07-70
	Washer, Flat, (Ø.516" x Ø.875" x .063") (Not Shown)	4	N/A	N/A	N/A	15-6720-07-70	N/A	15-6720-07-70

* See elastomer chart - Section 9

¹Air Valve Assembly includes items 2 and 3.

²Center Block Assembly includes items 9, 10, 13, 15 and 16.

0030 Specialty Code = Screen Based

0070 Specialty Code = Saniflo™ FDA

All boldface items are primary wear parts.

Screen Base Assembly - / 0030 Specialty Code

Screen Base Assembly - / 0030 Specialty Code

Item	Description	Qty.	/0030 P/N
42	Manifold, Inlet	1	15-5080-01-30
43	Screen Base	1	15-5620-01
44	Suction Hook-up Cover	1	15-5660-01
45	Hex Machine Screw (3/8" - 16 x 7/8")	1	08-6140-08
46	Hex Nut (3/8" - 16)	2	08-6430-08
47	Hex Machine Screw (3/8" - 16 x 3")	2	08-6120-08

EXPLODED VIEW & PARTS LISTING

PX15 METAL

Reduced-Stroke Diaphragm-Fitted (Plastic Center Block Assm.)

EXPLODED VIEW

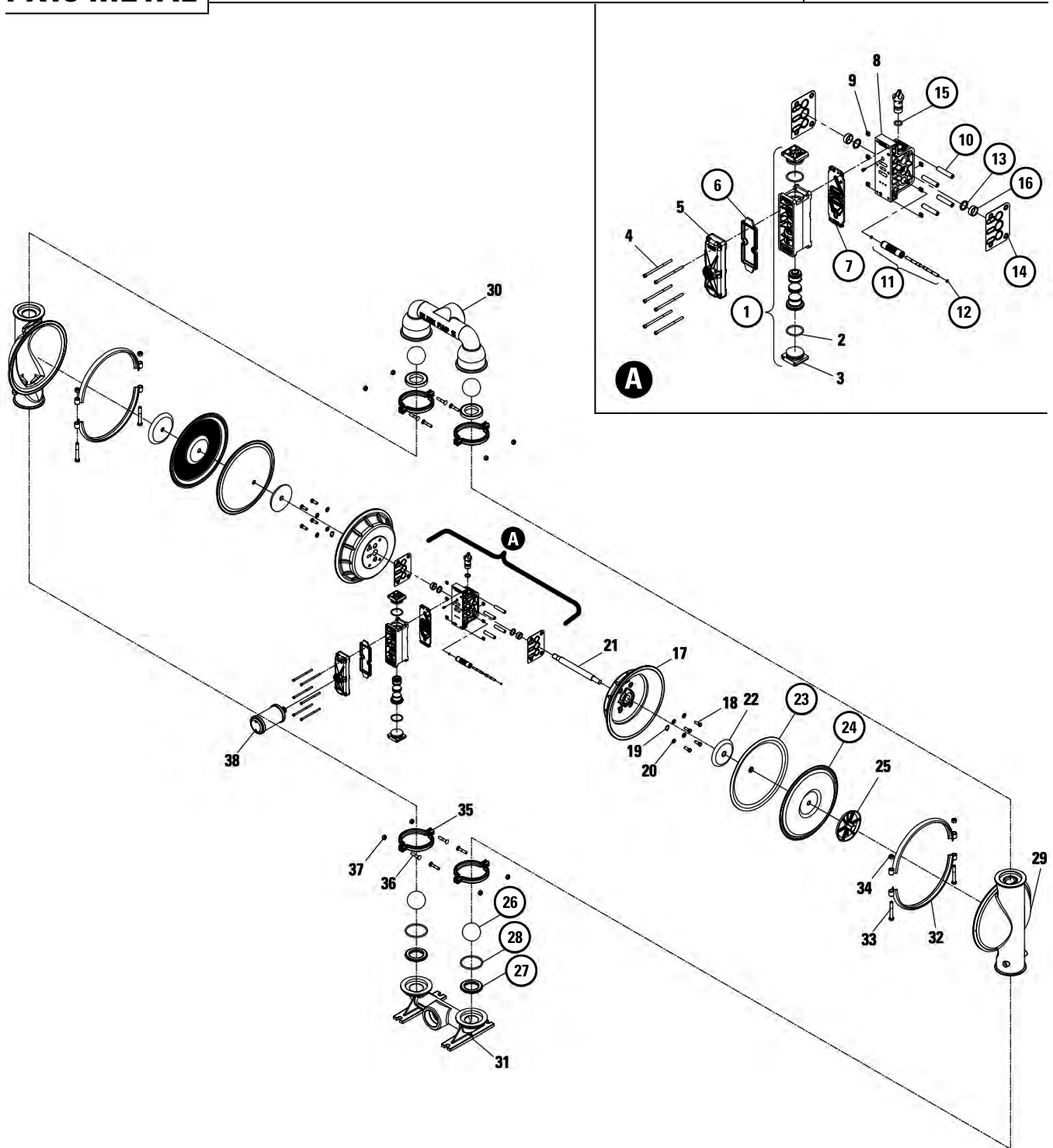



EXPLODED VIEW & PARTS LISTING



PX15 METAL

Reduced-Stroke Diaphragm-Fitted (Plastic Center Block Assm.)

PARTS LISTING

Item	Description	Qty.	PX15/AAAPP/ P/N	PX15/WWWPP/ P/N	PX15/SSAPP/ P/N	PX15/SSAPP/0070 P/N	PX15/SSSPP/ P/N	PX15/SSSPP/0070 P/N
1	Pro-Flo V™ Assembly, Air Valve ¹	1	04-2030-20	08-2030-20	08-2030-20	08-2030-20	08-2030-20	08-2030-20
2	O-Ring (-225), End Cap (Ø1.859" x Ø.139")	2	04-2390-52-700	04-2390-52-700	04-2390-52-700	04-2390-52-700	04-2390-52-700	04-2390-52-700
3	End Cap	2	04-2330-20-700	04-2330-20-700	04-2330-20-700	04-2330-20-700	04-2330-20-700	04-2330-20-700
4	Screw, SHC, Air Valve (1/4"-20 x 4-1/2")	6	01-6000-03	01-6000-03	01-6000-03	01-6000-03	01-6000-03	01-6000-03
5	Muffler Plate, Pro-Flo V™	1	08-3185-20	08-3185-20	08-3185-20	08-3185-20	08-3185-20	08-3185-20
6	Gasket, Muffler Plate, Pro-Flo V™	1	08-3502-52	08-3502-52	08-3502-52	08-3502-52	08-3502-52	08-3502-52
7	Gasket, Air Valve, Pro-Flo V™	1	08-2620-52	08-2620-52	08-2620-52	08-2620-52	08-2620-52	08-2620-52
8	Center Block Assembly, Pro-Flo X™ ²	1	15-3126-20	15-3126-20	15-3126-20	15-3126-20	15-3126-20	15-3126-20
9	Nut, Square, 1/4"-20	6	00-6505-03	00-6505-03	00-6505-03	00-6505-03	00-6505-03	00-6505-03
10	Sleeve, Threaded, C-Blk, Pro-Flo	4	04-7710-08	04-7710-08	04-7710-08	04-7710-08	04-7710-08	04-7710-08
11	Pilot Sleeve Assembly	1	15-3884-99	15-3884-99	15-3884-99	15-3884-99	08-3880-99	08-3880-99
12	Pilot Spool Retaining O-Ring	2	04-2650-49-700	04-2650-49-700	04-2650-49-700	04-2650-49-700	04-2650-49-700	04-2650-49-700
13	Shaft Seal	2	15-3210-55-225	15-3210-55-225	08-3210-55-225	08-3210-55-225	08-3210-55-225	08-3210-55-225
14	Gasket, Center Block Pro-Flo V™	2	04-3529-52	04-3529-52	04-3529-52	04-3529-52	04-3529-52	04-3529-52
15	O-Ring (-210), Adjuster (Ø.734" x Ø.139")	1	02-3200-52	02-3200-52	02-3200-52	02-3200-52	02-3200-52	02-3200-52
16	Bushing, Shaft	2	15-3306-13	15-3306-13	15-3306-13	15-3306-13	15-3306-13	15-3306-13
17	Air Chamber, Pro-Flo	2	15-3660-01	15-3660-02	15-3660-01	15-3660-01	15-3660-03	15-3660-03
18	Screw, HHC (3/8"-16 x 1-1/8")	8	15-6130-08	15-6130-08	15-6130-08	15-6130-08	15-6130-03	15-6130-03
19	Retaining Ring	2	04-3890-03	04-3890-03	04-3890-03	04-3890-03	04-3890-03	04-3890-03
20	Washer, Flat (Ø.406" x Ø.812" x .065")	8	15-6740-08-50	15-6740-08-50	15-6740-08-50	15-6740-08-50	15-6740-03-50	15-6740-03-50
21	Shaft	1	15-3805-09	15-3805-09	15-3805-09	15-3805-09	15-3805-09	15-3805-09
22	Piston, Inner	2	15-3750-01	15-3750-01	15-3750-01	15-3750-01	15-3752-03	15-3752-03
	Piston Inner, Ultra-Flex™	2	15-3760-08	15-3760-08	15-3760-08	N/A	15-3760-08	N/A
23	Back-up Diaphragm	2	*	*	*	*	*	*
24	Diaphragm	2	15-1010-55	15-1010-55	15-1010-55	15-1010-55	15-1010-55	15-1010-55
	Ultra-Flex™	2	*	*	*	*	*	*
25	Piston, Outer	2	15-4600-03	15-4600-03	15-4600-03	15-4600-03P	15-4600-03	15-4600-03P
	Piston Outer, Ultra-Flex™	2	15-4560-01	15-4560-02	15-4560-03	N/A	15-4560-03	N/A
26	Ball, Valve	4	15-1080-55	15-1080-55	15-1080-55	15-1080-55	15-1080-55	15-1080-55
27	Seat, Valve	4	15-1121-01	15-1121-08	15-1121-03	15-1121-03P	15-1121-03	15-1121-03
28	PTFE Valve Seat O-Ring	4	15-1200-55	15-1200-55	15-1200-55	15-1200-55	15-1200-55	15-1200-55
29	Liquid Chamber	2	15-5000-01	15-5000-02	15-5000-03	15-5000-03P	15-5000-03	15-5000-03P
30	Manifold, Discharge	1	15-5020-01	15-5020-02	15-5020-03	15-5020-03-70P	15-5020-03	15-5020-03-70P
31	Manifold, Footed Inlet	1	15-5080-01	15-5080-02	15-5080-03	15-5080-03-70P	15-5080-03	15-5080-03-70P
32	Large Clamp Band Assembly	2	15-7300-08	15-7300-08	15-7300-03	15-7300-03	15-7300-03	15-7300-03
33	Large Hex Bolt (1/2"-13 x 3-1/2")	4	15-6120-08	15-6120-08	15-6120-03	15-6120-03	15-6120-03	15-6120-03
34	Large Hex Nut (1/2"-13)	4	15-6420-08	15-6420-08	15-6420-03	15-6671-10	15-6420-03	15-6671-10
35	Small Clamp Band Assembly	4	15-7100-08	15-7100-08	15-7100-03	15-7100-08	15-7100-03	15-7100-03
36	Small Hex Bolt (3/8"-16 x 2")	8	15-6050-08	15-6050-08	15-6050-03	15-6050-03	15-6050-03	15-6050-03
37	Small Hex Nut (3/8"-16)	8	08-6450-08	08-6450-08	08-6450-03	08-6671-10	08-6450-03	08-6671-10
38	Muffler	1	15-3510-99R	15-3510-99R	15-3510-99R	15-3510-99R	15-3510-99R	15-3510-99R
	Washer, Flat, (Ø.392" x Ø.875" x .062") (Not Shown)	8	N/A	N/A	N/A	08-6720-07-70	N/A	08-6720-07-70
	Washer, Flat, (Ø.516" x Ø.875" x .063") (Not Shown)	4	N/A	N/A	N/A	15-6720-07-70	N/A	15-6720-07-70

* See elastomer chart - Section 9

¹Air Valve Assembly includes items 2 and 3.

²Center Block Assembly includes items 9, 10, 13, 15 and 16.

0070 Specialty Code = Saniflo™ FDA

All boldface items are primary wear parts.

EXPLODED VIEW & PARTS LISTING

PX15 METAL SANIFLO™

1935/2004/EC

EXPLODED VIEW

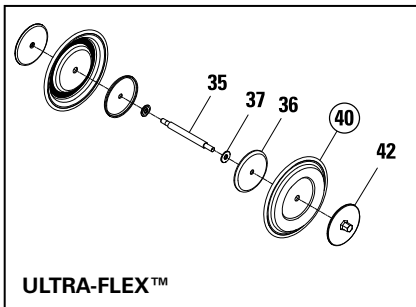
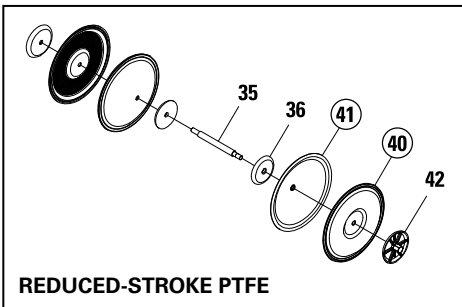
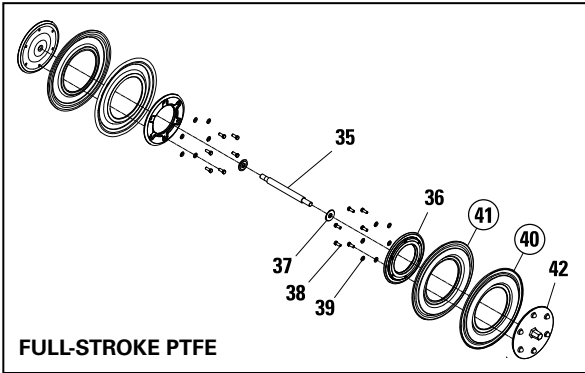
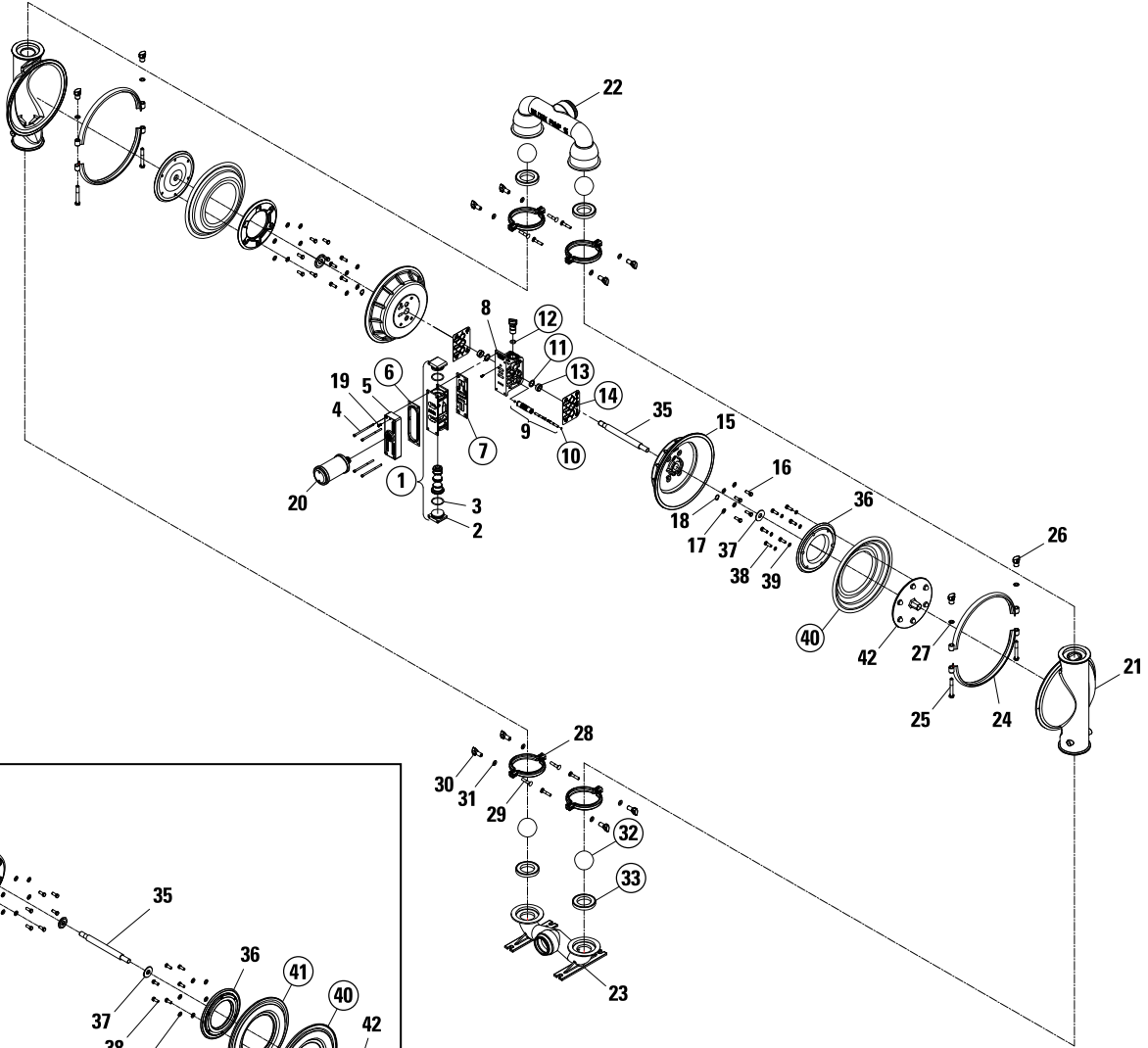

LW0102, Rev. A



EXPLODED VIEW & PARTS LISTING



PX15 METAL SANIFLO™

1935/2004/EC

PARTS LISTING

Item	Description	Qty.	XPX15/SSAAA/ 1935/2004/EC P/N	XPX15/SSNNN/ 1935/2004/EC P/N	XPX15/SSSSS/ 1935/2004/EC P/N
AIR DISTRIBUTION COMPONENTS					
1	Air Valve Assembly, Pro-Flo¹	1	04-2030-01	04-2030-06	04-2039-01
2	End Cap	2	04-2340-01	04-2340-06	04-2340-03
3	O-Ring (-225), End Cap (Ø1.859" x Ø.139")	2	04-2390-52-700	04-2390-52-700	04-2390-52-700
4	Screw, SHC, Air Valve (1/4" -20 x 4-1/2")	4	01-6000-03	01-6000-03	01-6000-03
5	Muffler Plate, Pro-Flo V™	1	04-3185-01	04-3185-06	04-3185-03
6	Gasket, Muffler Plate, Pro-Flo V™	1	04-3502-52	04-3502-52	04-3502-52
7	Gasket, Air Valve, Pro-Flo V™	1	04-2620-52	04-2620-52	04-2620-52
8	Center Block Assembly, Pro-Flo X™ ²	1	15-3126-01	15-3126-06	15-3126-03
9	Pilot Sleeve Assembly	1	15-3884-99	15-3884-99	15-3884-99
10	O-Ring (-009), Pilot Spool Retaining (Ø.208" x Ø.070")	2	04-2650-49-700	04-2650-49-700	04-2650-49-700
11	Seal, Shaft	2	15-3210-55-225	15-3210-55-225	15-3210-55-225
12	O-Ring (-210), Adjuster (Ø.734" x Ø.139")	2	02-3200-52	02-3200-52	02-3200-52
13	Bushing, Shaft	2	15-3306-13	15-3306-13	15-3306-13
14	Gasket, Center Block Pro-Flo V™	2	04-3529-52	04-3529-52	04-3529-52
15	Air Chamber, Pro-Flo V™	2	15-3660-01	15-3660-06	15-3660-03
16	Screw, HHC (3/8"-16 x 1-1/8")	8	15-6130-08	N/A	N/A
	Screw, HHC (3/8"-16 x 1")	8	N/A	08-6130-03	08-6130-03
17	Washer, Flat (Ø.406" x Ø.812" x .065")	8	15-6740-08-50	04-6740-03	04-6740-03
18	Retaining Ring	2	04-3890-03	04-3890-03	04-3890-03
19	Grounding Screw, (10-32 x .50") Self Tapping	1	04-6345-08	04-6345-08	04-6345-08
20	Muffler, Metal 1" MNPT	1	15-3510-99R	15-3510-99R	15-3513-99
WETTED PATH COMPONENTS					
21	Liquid Chamber	2	15-5000-03P	15-5000-03P	15-5000-03P
22	Manifold, Discharge Tri-Clamp	1	15-5020-03-70P	15-5020-03-70P	15-5020-03-70P
23	Manifold, Footed Inlet Tri-clamp	1	15-5080-03-70P	15-5080-03-70P	15-5080-03-70P
24	Large Clamp Band Assembly	2	15-7300-03-70	15-7300-03-70	15-7300-03-70
25	Screw, HHC Large (1/2"-13 x 3-3/4")	4	15-6120-03	15-6120-03	15-6120-03
26	Wing Nut, Large Clamp Band (1/2"-13)	4	15-6671-10	15-6671-10	15-6671-10
27	Washer, Brass Flat (Ø.516" x Ø.875" x .063")	4	15-6720-07-70	15-6720-07-70	15-6720-07-70
28	Small Clamp Band Assembly	4	15-7100-03-70	15-7100-03-70	15-7100-03-70
29	RHSN Bolt, Small Clamp Band (3/8" -16 x 2")	8	15-6050-03	15-6050-03	15-6050-03
30	Wing Nut, Small Clamp Band (3/8"-16)	8	08-6671-10	08-6671-10	08-6671-10
31	Washer, Brass Flat (Ø.392" x Ø.875" x .063")	8	08-6720-07-70	08-6720-07-70	08-6720-07-70
VALVE BALLS/VALVE SEATS/VALVE O-RINGS					
32	Ball, Valve, Pkg 4	1	*	*	*
33	Seat, Valve, Pkg 4	1	*	*	*
	Seat, Valve, Stainless Steel	4	15-1121-03E	15-1121-03E	15-1121-03E
34	O-Ring (-342), Valve Seat (Ø3.600" x Ø.210"), (Not Shown), Pkg 4	1	15-1200-55E	15-1200-55E	15-1200-55E

¹Air Valve Assembly includes items 2 and 3.

²Metal Center Block Assembly includes items 11 and 12.

All boldface items are primary wear parts.

LW0089, Rev. A



EXPLODED VIEW & PARTS LISTING, CONT.

PX15 METAL SANIFLO™

1935/2004/EC

EXPLODED VIEW

Item	Description	Qty.	XPX15/SSAAA/ 1935/2004/EC P/N	XPX15/SSNNN/ 1935/2004/EC P/N	XPX15/SSSSS/ 1935/2004/EC P/N
FULL-STROKE RUBBER/TPE/PTFE COMPONENTS					
35	Shaft	1	15-3805-09	15-3805-09	15-3805-09
36	Piston, Inner	2	15-3700-01	15-3700-01	15-3700-03
37	Washer, Inner Piston Back-up	2	15-6850-08	15-6850-08	15-6850-08
38	Screw, HHC (3/8" -16 x 1-1/8")	12	15-6130-08	N/A	N/A
	Screw, HHC (3/8" -16 x 1")	12	N/A	08-6130-03	08-6130-03
39	Washer (Ø.406" x Ø.812" x .065")	12	15-6740-08-50	04-6740-03	04-6740-03
40	Diaphragm, Primary, Pkg 2	1	*	*	*
41	Diaphragm, Back-Up, Pkg 2	1	*	*	*
42	Piston, Outer	2	15-4550-03P	15-4550-03P	15-4550-03P
ULTRA-FLEX COMPONENTS					
35	Shaft	1	15-3805-09	15-3805-09	15-3805-09
36	Piston, Inner	2	15-3760-08	15-3760-08	15-3760-08
37	Washer, Inner Piston Back-up	2	15-6850-08	15-6850-08	15-6850-08
40	Diaphragm, Primary, Pkg 2	1	*	*	*
42	Piston, Outer	2	15-4560-03P	15-4560-03P	15-4560-03P
FULL STROKE IPD COMPONENTS					
35	Shaft	1	15-3805-09	15-3805-09	15-3805-09
36	Piston, Inner	2	15-3750-01	15-3752-03	15-3752-03
40	Diaphragm, Primary, Pkg 2	1	*	*	*
41	Diaphragm, Back-Up, Pkg 2	1	*	*	*
42	Piston, Outer	2	15-4600-03P	15-4600-03P	15-4600-03P

LW0089, Rev. A

¹Air Valve Assembly includes items 2 and 3.

²Metal Center Block Assembly includes items 11 and 12.

All boldface items are primary wear parts.



ELASTOMER OPTIONS

PX15 METAL

MATERIAL	DIAPHRAGMS (2)	ULTRA-FLEX™ DIAPHRAGMS (2)	REDUCED-STROKE BACK-UP DIAPHRAGM (2)	FULL-STROKE BACK-UP DIAPHRAGM (2)	VALVE BALLS (4)	VALVE SEATS (4)	VALVE SEAT O-RINGS (4)
Polyurethane	15-1010-50	N/A	N/A	N/A	15-1080-50	15-1120-50	N/A
Neoprene	15-1010-51	15-1020-51*	15-1060-51	N/A	15-1080-51	15-1120-51	N/A
Buna-N	15-1010-52	15-1020-52*	N/A	N/A	15-1080-52	15-1120-52	N/A
EPDM	15-1010-54	15-1020-54*	15-1060-54	N/A	15-1080-54	15-1120-54	N/A
Viton®	15-1010-53	15-1020-53*	N/A	N/A	15-1080-53	15-1120-53	N/A
Saniflex™	15-1010-56	N/A	15-1060-56	15-1065-56	15-1080-56	15-1120-56	N/A
PTFE	15-1010-55	N/A	N/A	N/A	15-1080-55	N/A	15-1200-55 ¹
Full-Stroke PTFE	15-1040-55	N/A	N/A	N/A	N/A	N/A	N/A
Wil-Flex™	15-1010-58	N/A	N/A	15-1065-57	15-1080-58	15-1120-58	N/A
Aluminum	N/A	N/A	N/A	N/A	N/A	15-1121-01	N/A
Stainless Steel	N/A	N/A	N/A	N/A	N/A	15-1121-03	N/A
Mild Steel	N/A	N/A	N/A	N/A	N/A	15-1121-08	N/A

*Consult P/S UF for Ultra-Flex™ information.

¹Used on metallic seat only.

Back-up diaphragms for use with PTFE diaphragms only.

PX15 METAL SANIFLO™ 1935/2004/EC

MATERIAL	DIAPHRAGMS	REDUCED-STROKE BACK-UP DIAPHRAGMS	ULTRA-FLEX™ DIAPHRAGMS	FULL-STROKE DIAPHRAGMS	FULL-STROKE BACK-UP DIAPHRAGMS	EZ-INSTALL DIAPHRAGMS	VALVE BALLS	VALVE SEATS
FDA Buna-N	N/A	N/A	15-1020-52E	N/A	N/A	N/A	N/A	N/A
FDA EPDM	N/A	15-1060-54E	15-1020-54E	N/A	N/A	N/A	N/A	N/A
FDA Wil-Flex™	N/A	N/A	N/A	15-1040-55E	15-1065-57E	15-1022-57E	N/A	N/A
Saniflex™	15-1010-56E	15-1060-56E	N/A	N/A	15-1065-56E	15-1022-56E	15-1080-56E	15-1120-56E
PTFE	15-1010-55E	N/A	N/A	N/A	N/A	N/A	15-1080-55E	N/A

LW0089, Rev. A

ELASTOMER KITS OPTIONS

PRO-FLO X™

DESCRIPTION	NEOPRENE	BUNA-N	VITON®	EPDM
Original™ Metal	15-9582-51	15-9582-52	15-9582-53	15-9582-54
Original™ Metal (Ultra-Flex™)	15-9592-51	15-9592-52	15-9592-53	15-9592-54
DESCRIPTION	REDUCED-STROKE PTFE	WIL-FLEX™	SANIFLEX™	POLYURETHANE
Original™ Metal	15-9582-55	15-9582-58	15-9582-56	15-9582-50

WILDEN®

Part of Pump Solutions Group

A DOVER COMPANY

DECLARATION OF COMPLIANCE

STATEMENT OF COMPLIANCE TO REGULATIONS (EC) No 1935/2004
ON MATERIALS AND ARTICLES INTENDED TO COME INTO CONTACT WITH FOOD
(as per Article 16 of REGULATION (EC) No 1935/2004)



Wilden® Pump & Engineering, LLC, 22069 Van Buren Street, Grand Terrace, CA 92313-5607 USA, declares the equipment listed below intended to come into contact with food comply with the requirements of Regulation (EC) No 1935/2004 of 27th October 2004 and (EC) No 2023/2006 of 22nd December 2006.

- **Saniflo™ HS Models:**
(P,X,XPX)(2,4,8,15)/(SS,SZ)(SSS,NNN)/(BNU,EPU,FBS,FES,FSS,FWL,FWS,LEL,TEU,TSS,TSU,TWS,ZSS)/
(FB,FE,FS,FV,FW,SF,TF,TM)/(FB,FE,FV,TF)/(0770-0789)E
- **13 mm (½") FDA Pro-Flo® & Pro-Flo X™ Models:**
(P,PX,XPX)1/(SS,SZ)(AAA,GGG,JJJ,LLL,PPP)/(FSS,TEU,TSU)/(FS,TF)/S(FS,TF)/(0067,0070,0120)E
- **25 mm (1") FDA Pro-Flo® Models:**
P2/(SS,SZ)(LLL,PPP)/(FBS,FES,FSS,FWL,FWS,LEL,TEU,TSS,TSU,TWS)/(FS,TF)/S(FS,TF)/2070E
- **38 mm (1-½") FDA Pro-Flo® & Pro-Flo X™ Models:**
(P,PX,XPX)4/(SS,SZ)(A,C,L,N,S,V)(AA,LL,NN,PP,SS)/(BNU,EPU,FBS,FES,FSS,FWL,FWS,LEL,TEU,TSS,TSU,TWS,ZSS)/
(FB,FE,FS,FV,FW,TF,)/(FS,FW,STF)/(0067,0070,0075,0120)E
- **51 mm (2") FDA Pro-Flo® & Pro-Flo X™ Models:**
(P,PX,XPX)8/SS(A,C,N,S,V)(AA,NN,PP,SS)/(BNU,EPU,FBS,FES,FSS,FWS,FWL,TEU,TSU,TSS,TWS,ZSS)/(FS,FW,TF)/
(FS,FW,STF)/(0070,0075,0120)E
- **76 mm (3") FDA Pro-Flo X™ Models:**
(P,X,XPX)15/SS(A,C,N,S)(AA,SS,PP)/(BNU,EPU,FSS,FWS,TEU,TSU,TSS,TWS,ZSS)/(FS,FW,TF)/(FS,FW,STF)/
(0070,0075,0120,0341)E
- **38 mm (1-½") FDA Pro-Flo® SHIFT Models:**
XPS4/(SS,SZ)(AAA,NNN)/(FBS,FES,FWL,FWS,TSS,TWS,ZSS)/(FS,FW,TF)/(FS,FW,STF)/(0067,0070,0075,0120)E
- **51 mm (2") FDA Pro-Flo® SHIFT Models:**
XPS8/(SS,SZ)(AAA,NNN)/(FBS,FES,FWL,FWS,TSS,TWS,ZSS)/(FS,FW,TF)/(FS,FW,STF)/(0070,0075,0120)E
- **76 mm (3") FDA Pro-Flo® SHIFT Models:**
XPS15/(SS,SZ)(AAA,NNN)/(FWS,TSS,TWS,ZSS)/(FS,FW,TF)/(FS,FW,STF)/(0070,0120,0341)E

Materials used in the equipment that are intended to contact food belong to the groups of materials listed in Annex 1 (EC) 1935/2004.
(List of groups of materials and articles that may be covered by specific measures)

5) Rubbers

8) Metal and Alloy

10) Plastics

Compliance is subject to material and equipment storage, handling and usage recommended by Wilden® in the engineering operation and maintenance manual and supplemental technical publications.

This declaration is based on the following information:

Statements of raw material suppliers

Wilden® will make available to the competent authorities appropriate documentation to demonstrate compliance.

Approved By:

Chris Distaso

Director of Engineering

Date: March 21, 2014

PSG
PUMP SOLUTIONS GROUP
A DOVER COMPANY
www.psgdover.com

NOTES

NOTES

WARRANTY

Each and every product manufactured by Wilden Pump and Engineering, LLC is built to meet the highest standards of quality. Every pump is functionally tested to insure integrity of operation.

Wilden Pump and Engineering, LLC warrants that pumps, accessories and parts manufactured or supplied by it to be free from defects in material and workmanship for a period of five (5) years from date of installation or six (6) years from date of manufacture, whichever comes first. Failure due to normal wear, misapplication, or abuse is, of course, excluded from this warranty.

Since the use of Wilden pumps and parts is beyond our control, we cannot guarantee the suitability of any pump or part for a particular application and Wilden Pump and Engineering, LLC shall not be liable for any consequential damage or expense arising from the use or misuse of its products on any application. Responsibility is limited solely to replacement or repair of defective Wilden pumps and parts.

All decisions as to the cause of failure are the sole determination of Wilden Pump and Engineering, LLC.

Prior approval must be obtained from Wilden for return of any items for warranty consideration and must be accompanied by the appropriate MSDS for the product(s) involved. A Return Goods Tag, obtained from an authorized Wilden distributor, must be included with the items which must be shipped freight prepaid.

The foregoing warranty is exclusive and in lieu of all other warranties expressed or implied (whether written or oral) including all implied warranties of merchantability and fitness for any particular purpose. No distributor or other person is authorized to assume any liability or obligation for Wilden Pump and Engineering, LLC other than expressly provided herein.

PLEASE PRINT OR TYPE AND FAX TO WILDEN

PUMP INFORMATION			
Item # _____		Serial # _____	
Company Where Purchased _____			
YOUR INFORMATION			
Company Name _____			
Industry _____			
Name _____		Title _____	
Street Address _____			
City _____	State _____	Postal Code _____	Country _____
Telephone _____	Fax _____	E-mail _____	Web Address _____
Number of pumps in facility? _____		Number of Wilden pumps? _____	
Types of pumps in facility (check all that apply): <input type="checkbox"/> Diaphragm <input type="checkbox"/> Centrifugal <input type="checkbox"/> Gear <input type="checkbox"/> Submersible <input type="checkbox"/> Lobe			
<input type="checkbox"/> Other _____			
Media being pumped? _____			
How did you hear of Wilden Pump? <input type="checkbox"/> Trade Journal <input type="checkbox"/> Trade Show <input type="checkbox"/> Internet/E-mail <input type="checkbox"/> Distributor			
<input type="checkbox"/> Other _____			

ONCE COMPLETE, FAX TO (909) 783-3440

NOTE: WARRANTY VOID IF PAGE IS NOT FAXED TO WILDEN

WILDEN PUMP & ENGINEERING, LLC

PSG Brands

ABAQUE™
PERISTALTIC PUMPS
mouvex.com

ALMATEC®
AIR-OPERATED
DOUBLE-DIAPHRAGM PUMPS
almatec.de

AUTOMATIK
PELLETIZING SYSTEMS
maag.com

BLACKMER®
VANE PUMPS & COMPRESSORS
blackmer.com

FLUID DYNAMICS™
POLYMER BLENDING SYSTEMS
fluiddynamics1.com

GRISWOLD™
CENTRIFUGAL PUMPS
griswoldpump.com

**MAAG
FILTRATION**
PLASTIC MANUFACTURING &
PROCESSING FILTRATION
maag.com

**MAAG
INDUSTRIAL PUMPS**
GEAR & SCREW PUMPS
maag.com

**MAAG
PUMP SYSTEMS**
EXTRUSION PUMPS & SYSTEMS
maag.com

MOUVEX®
ECCENTRIC DISC PUMPS,
VANE PUMPS &
COMPRESSORS
mouvex.com

NEPTUNE™
DIAPHRAGM (METERING) PUMPS,
POLYMER SYSTEMS & MIXERS
neptune1.com

QUATTROFLOW™
QUATERNARY DIAPHRAGM
PUMP TECHNOLOGY
quattroflow.com

REDSCREW™
SCREW PUMPS
redscrewpump.com

SYSTEM ONE®
CENTRIFUGAL PUMPS
blackmer.com

WILDEN®
AIR-OPERATED
DOUBLE-DIAPHRAGM PUMPS
wildenpump.com



Where Innovation Flows

PSG reserves the right to modify the information and illustrations contained in this document without prior notice. This is a non-contractual document. 01-2014

Authorized PSG Representative:

WILDEN®
Part of Pump Solutions Group
A DOVER COMPANY

22069 Van Buren St.
Grand Terrace, CA 92313-5607
T: +1 (909) 422-1731
F: +1 (909) 783-3440

Copyright ©2014, Pump Solutions Group (PSG), A Dover Company